



Approximately 7-9 meters in total body length and weighing between 3 and 10 tons, orcas (killer whales) are carnivorous mammals that live in oceans around the world. They are colored black and white. Their unique dorsal fins can grow to a maximum length of 2 meters and they are the fastest marine mammal around. Orcas are very savage and are natural-born hunters. They prey on fish, squid, seabirds, penguins, and at times, South American sea lions, seals, dolphins, polar bears, whales, and sharks as well. Differentiating between the sounds they emit allows them to communicate with each other.

- **Parts list (pattern) :Six A4 sheets**
- **Assembly Instructions : Three A4 sheets**

*Read the Assembly Instructions carefully in page order referring to the page numbers on the parts list.
 *It is easy to get pieces mixed up if you cut them all out at once, so just cut the pieces as you need them.
 *Coloring the sides of the papers in advance with a black magic marker may be a good idea so that they do not stand out against the black areas.
 *Red numbers are numbers of each respective part. Gray numbers are numbers of parts to be attached to red parts.
 *The numbers marked in green indicate the order to attach the parts.

Assembly Instructions

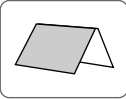
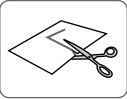
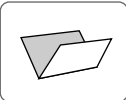
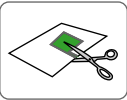
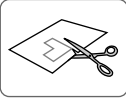
 <p>Mountain fold line (dotted line) ● Make a mountain fold.</p>	 <p>Slot line (solid line) ● Cut a slot.</p>
 <p>Valley fold line (dotted and dash line) ● Make a valley fold.</p>	 <p>Cut out ● Cut these areas out.</p>
 <p>Cut line (solid line) ● Cut out.</p>	

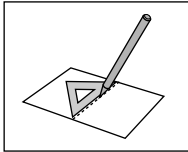
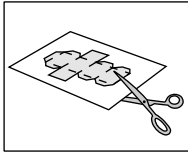
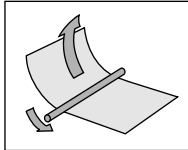
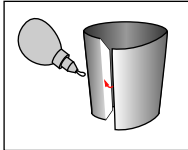
 <p>1. Use a set square or ruler and a dried up pen to score along the dotted lines, and fold along them to make creases.</p>	 <p>3. Use scissors to cut along the solid line.</p>
 <p>2. Work curves into the pieces using a metal rod before beginning assembly. For small pieces, add curves before cutting them out.</p>	 <p>4. The pale-colored numbers on the glue tabs indicate the number of the part to be attached there. Use a spatula for the small glue tabs.</p>

Tools and Materials



Scissors, set square, glue (such as woodwork glue), metal rod, spatula, a used pen, toothpicks, tweezers (useful for handling small parts).

Assembly tip



Before gluing, crease the paper along mountain fold and valley fold lines and make sure rounded sections are nice and stiff.

Caution



Glue, scissors and other tools may be dangerous to young children so be sure to keep them out of the reach of young children.

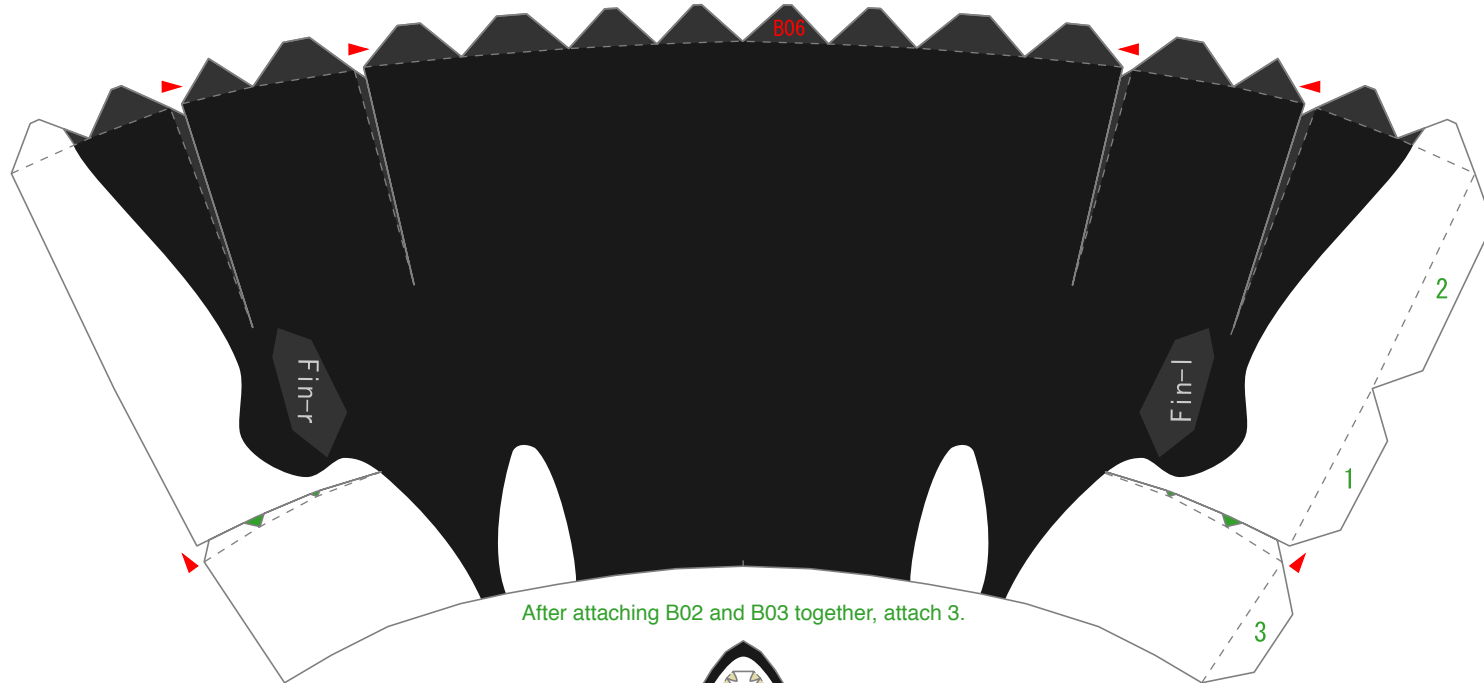

After attaching B02 and B03 together, attach 3.

In advance, make a slit in the circled part and gently curl it inward.

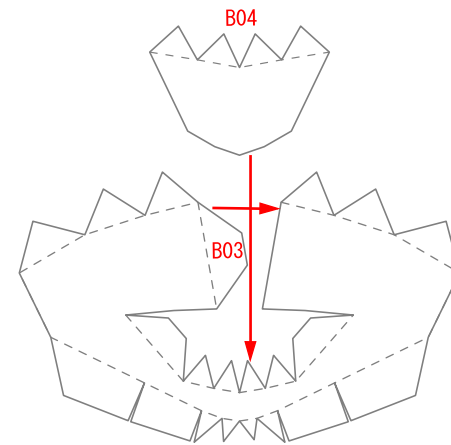
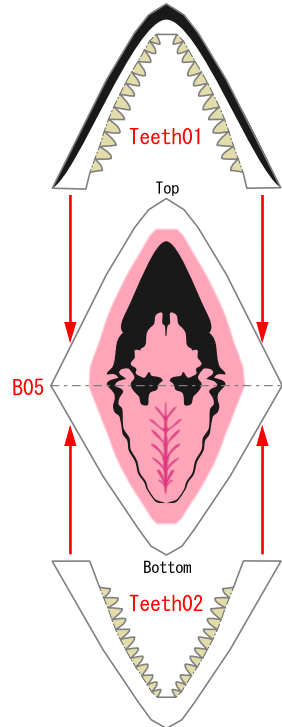
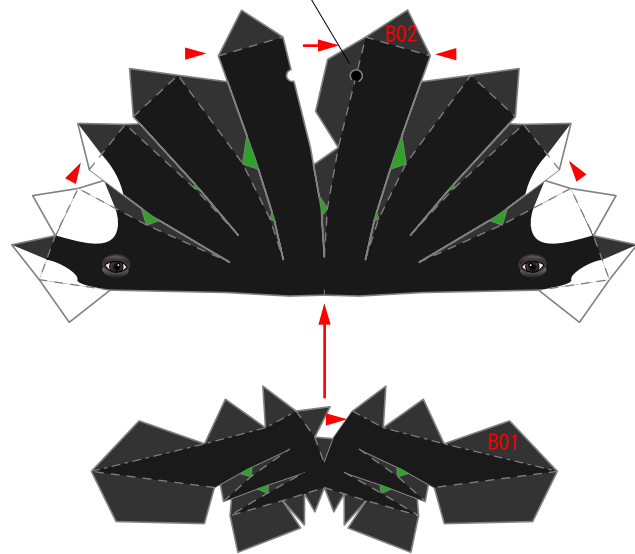

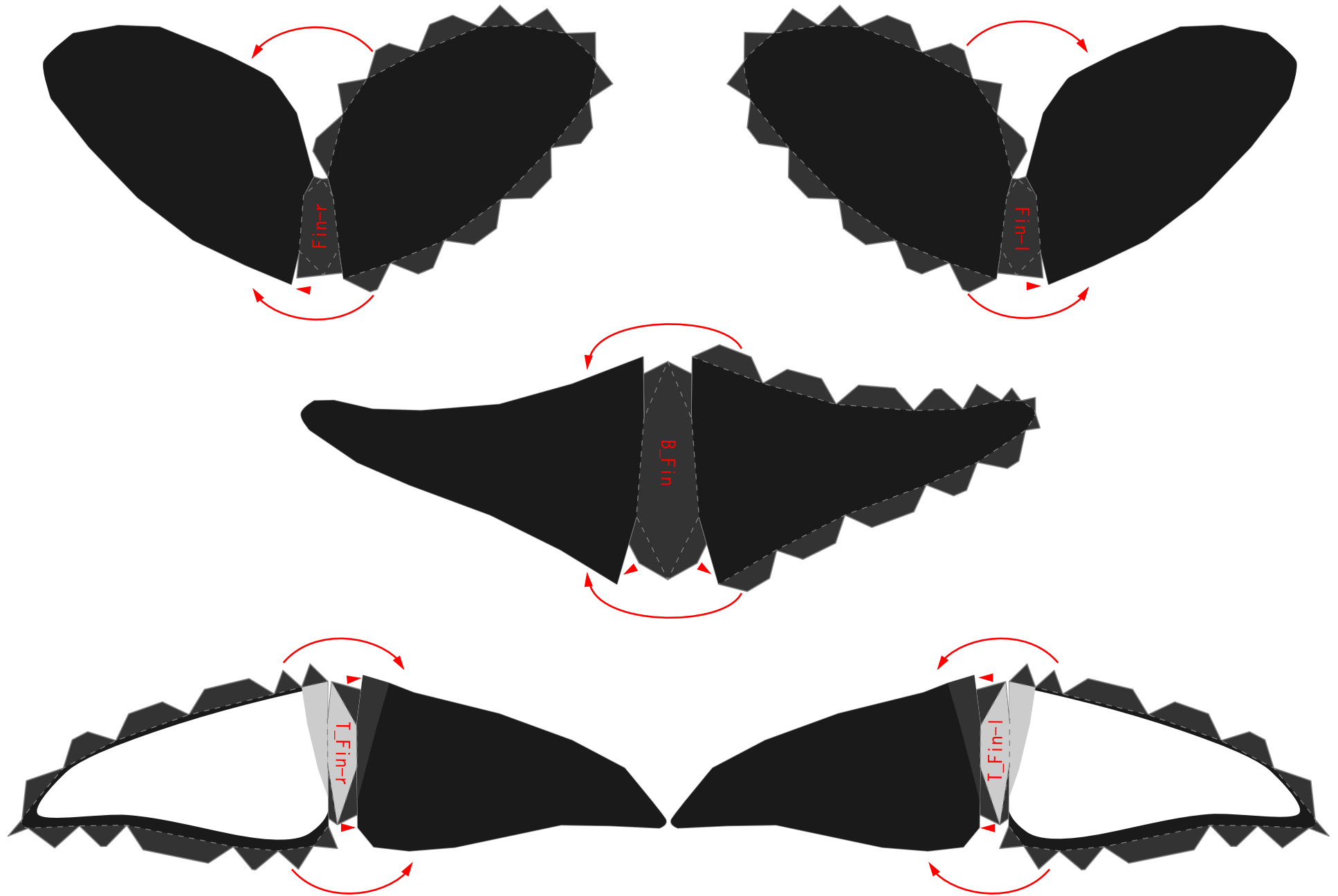

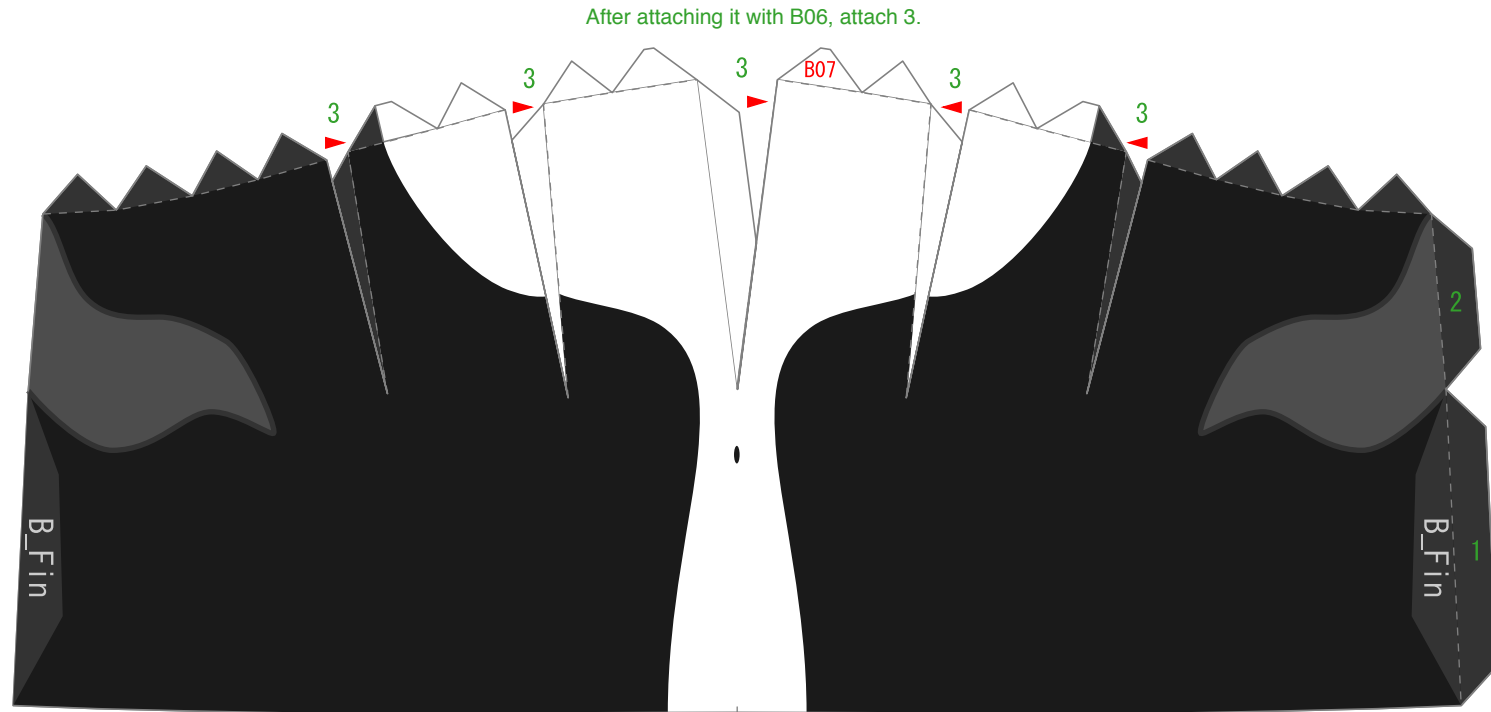

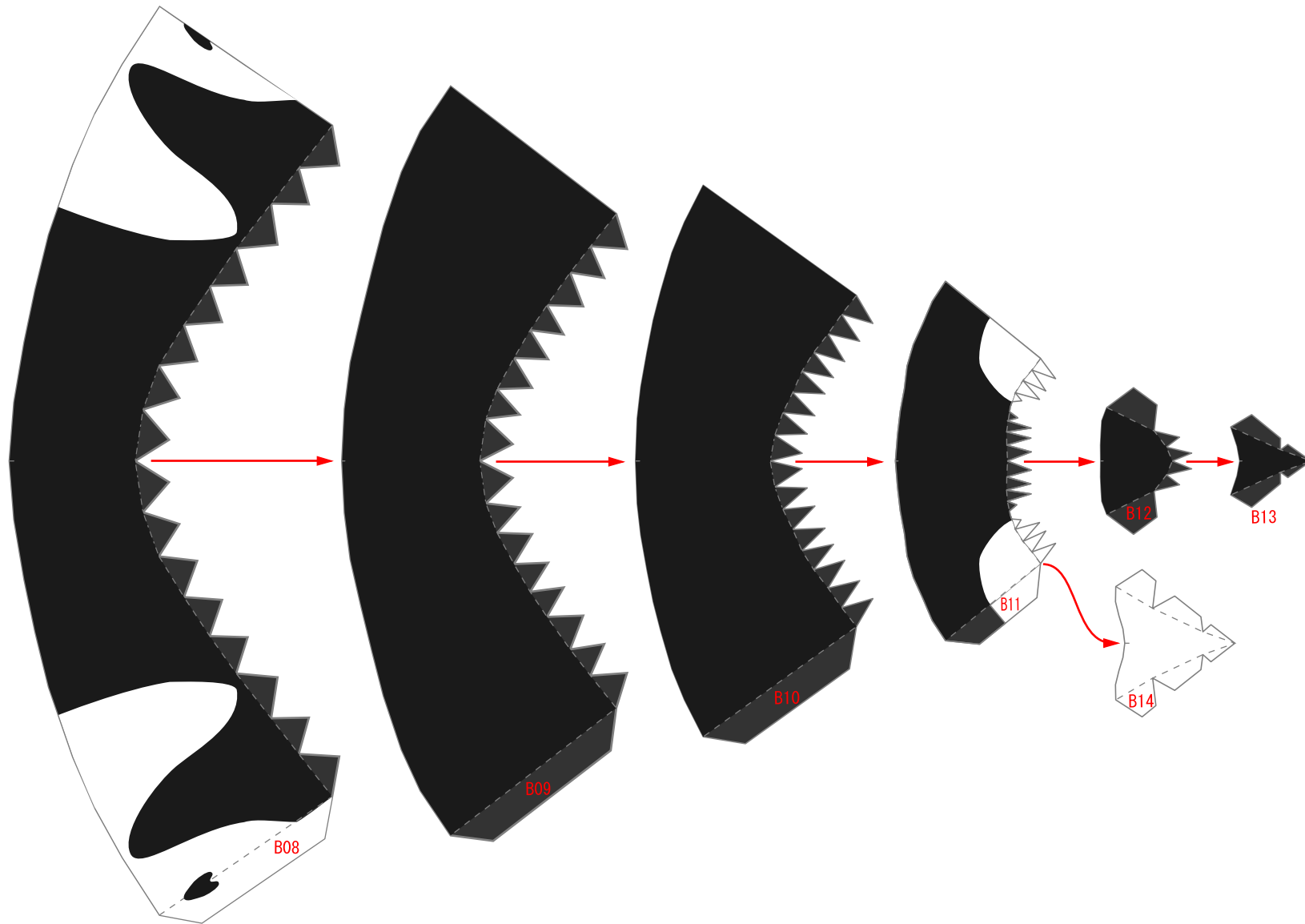

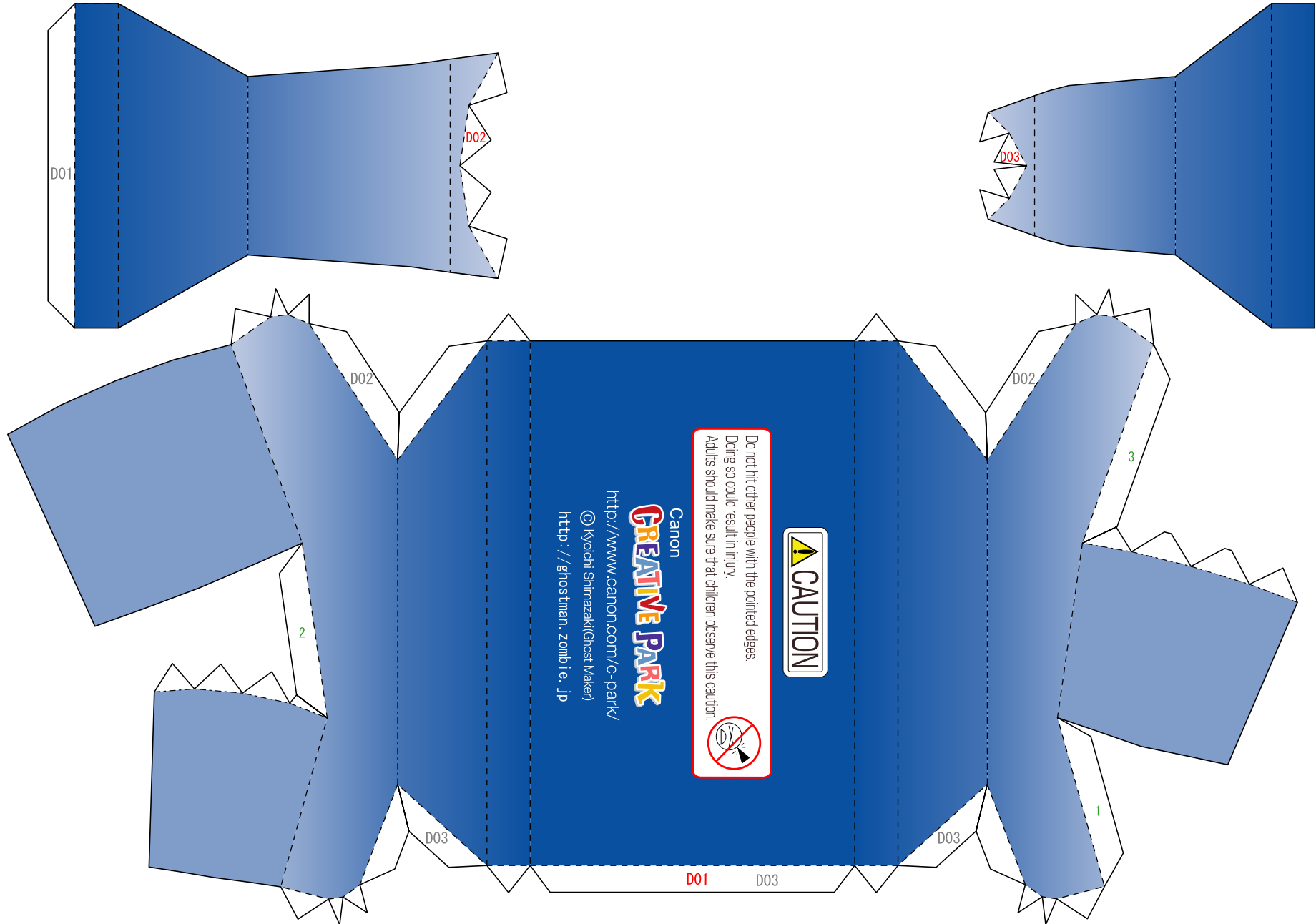





Approximately 7-9 meters in total body length and weighing between 3 and 10 tons, orcas (killer whales) are carnivorous mammals that live in oceans around the world. They are colored black and white. Their unique dorsal fins can grow to a maximum length of 2 meters and they are the fastest marine mammal around. Orcas are very savage and are natural-born hunters. They prey on fish, squid, seabirds, penguins, and at times, South American sea lions, seals, dolphins, polar bears, whales, and sharks as well. Differentiating between the sounds they emit allows them to communicate with each other.

- **Parts list (pattern) :Six A4 sheets**
- **Assembly Instructions : Three A4 sheets**

*Read the Assembly Instructions carefully in page order referring to the page numbers on the parts list.
 *It is easy to get pieces mixed up if you cut them all out at once, so just cut the pieces as you need them.
 *Coloring the sides of the papers in advance with a black magic marker may be a good idea so that they do not stand out against the black areas.
 *Red numbers are numbers of each respective part. Gray numbers are numbers of parts to be attached to red parts.
 *The numbers marked in green indicate the order to attach the parts.

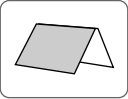
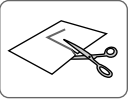
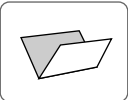
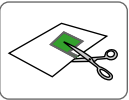
Assembly Instructions

 <p>Mountain fold line (dotted line) ● Make a mountain fold.</p>	 <p>Slot line (solid line) ● Cut a slot.</p>
 <p>Valley fold line (dotted and dash line) ● Make a valley fold.</p>	 <p>Cut line (solid line) ● Cut out.</p>
 <p>Cut out ● Cut these areas out.</p>	

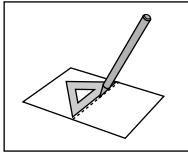
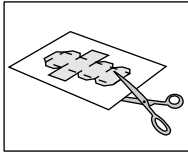
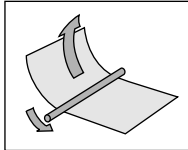
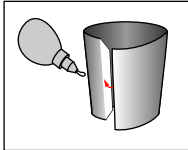
 <p>1. Use a set square or ruler and a dried up pen to score along the dotted lines, and fold along them to make creases.</p>	 <p>3. Use scissors to cut along the solid line.</p>
 <p>2. Work curves into the pieces using a metal rod before beginning assembly. For small pieces, add curves before cutting them out.</p>	 <p>4. The pale-colored numbers on the glue tabs indicate the number of the part to be attached there. Use a spatula for the small glue tabs.</p>

Tools and Materials



Scissors, set square, glue (such as woodwork glue), metal rod, spatula, a used pen, toothpicks, tweezers (useful for handling small parts).

Assembly tip



Before gluing, crease the paper along mountain fold and valley fold lines and make sure rounded sections are nice and stiff.

Caution



Glue, scissors and other tools may be dangerous to young children so be sure to keep them out of the reach of young children.

Glue tabs have been omitted from the diagrams to make them easier to understand.

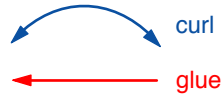

③. Fold up the teeth parts (Teeth01 and Teeth02) first and then attach them to B05.

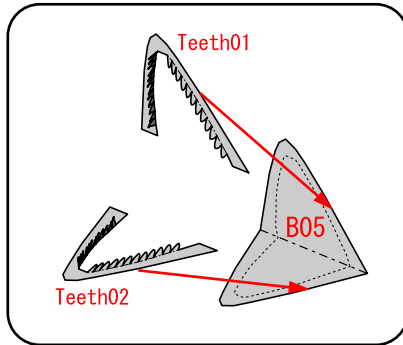

①. Attach B01 and B02 together, after assembling each part separately.
*Before attaching, make slits in the nostrils on the head part of B2 as well as the semicircle part, and curve them slightly.

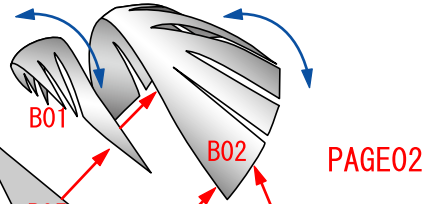

④. Attach B05 to B01 and B03. Then, attach B03 and B02 together.

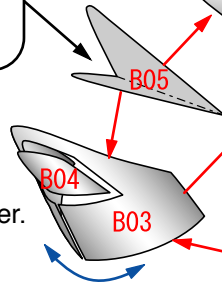

②. Assemble B03 and B04 and attach them together.

⑤. Add B06 (that has been curled into a cylindrical shape) to B02 and B03. If it is difficult to hold with your fingers, use a rod.

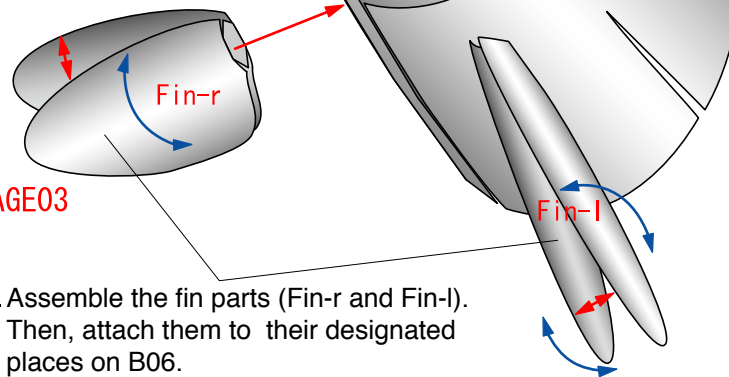

⑥. Assemble the fin parts (Fin-r and Fin-l). Then, attach them to their designated places on B06.

⑦. Assemble B_Fin.

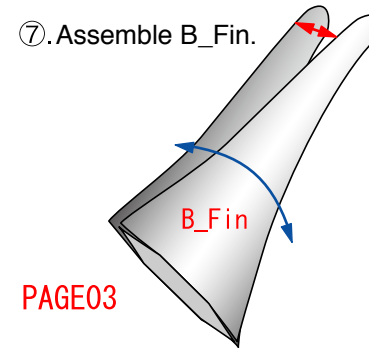

PAGE03

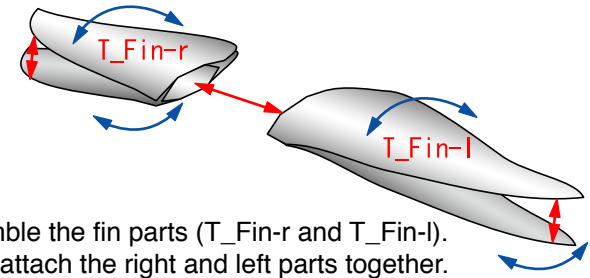

⑧. Assemble the fin parts (T_Fin-r and T_Fin-l). Then, attach the right and left parts together.

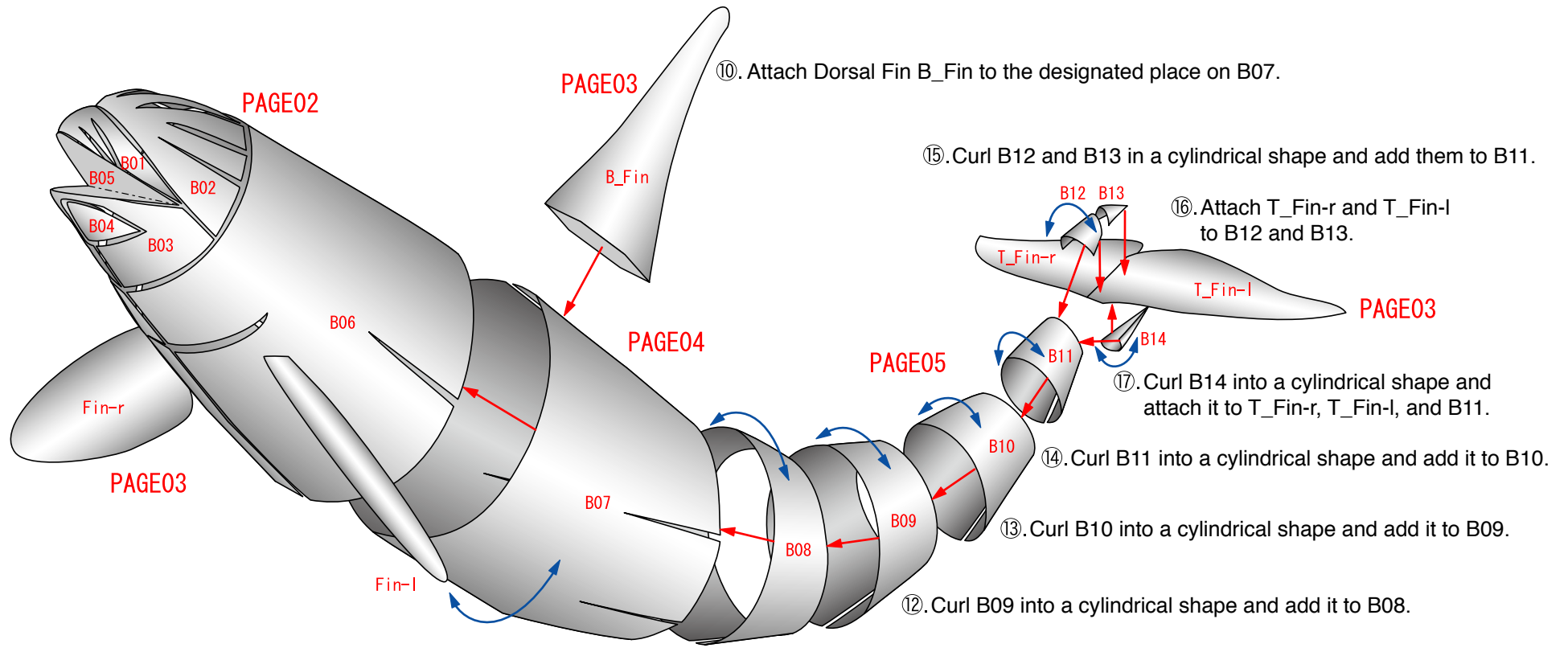

⑩. Attach Dorsal Fin B_Fin to the designated place on B07.

⑮. Curl B12 and B13 in a cylindrical shape and add them to B11.

⑯. Attach T_Fin-r and T_Fin-l to B12 and B13.

⑰. Curl B14 into a cylindrical shape and attach it to T_Fin-r, T_Fin-l, and B11.

⑭. Curl B11 into a cylindrical shape and add it to B10.

⑬. Curl B10 into a cylindrical shape and add it to B09.

⑫. Curl B09 into a cylindrical shape and add it to B08.

⑪. Curl B08 into a cylindrical shape and add it to B07.

⑨. Curl B07 into a cylindrical shape and add it to B06.

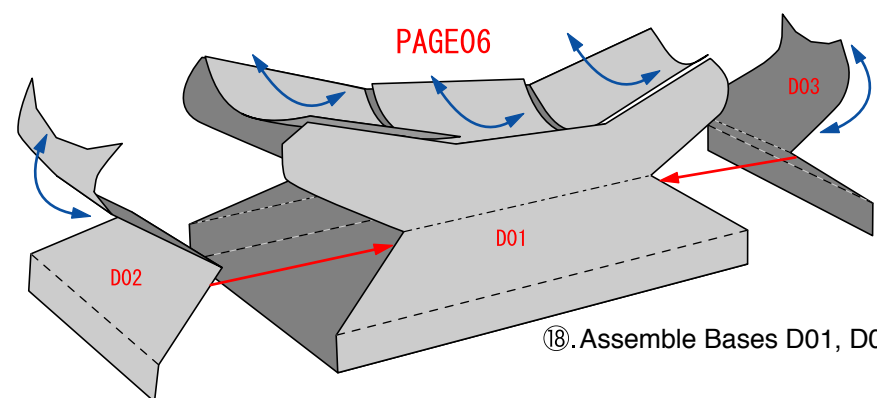

⑱. Assemble Bases D01, D02, and D03. Then, place the completed orca on top.