

A

1

1

1

3

2

G

G

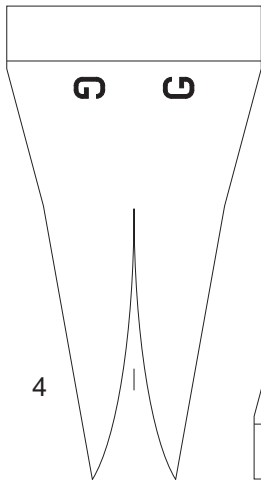

4

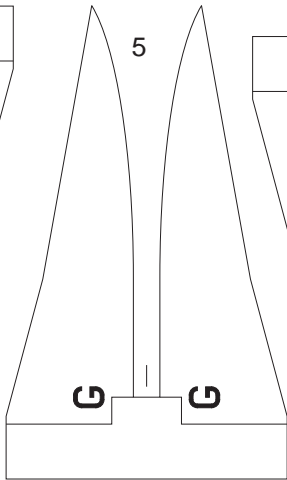

5

5

G

G

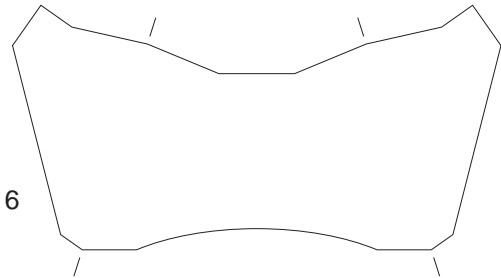

6



8

H.M. Airship R-100



H.M. Airship R-100

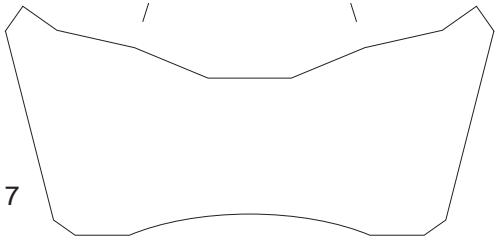

7

9

10

11

12

Open slots
(4 places)

13

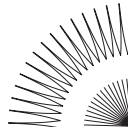
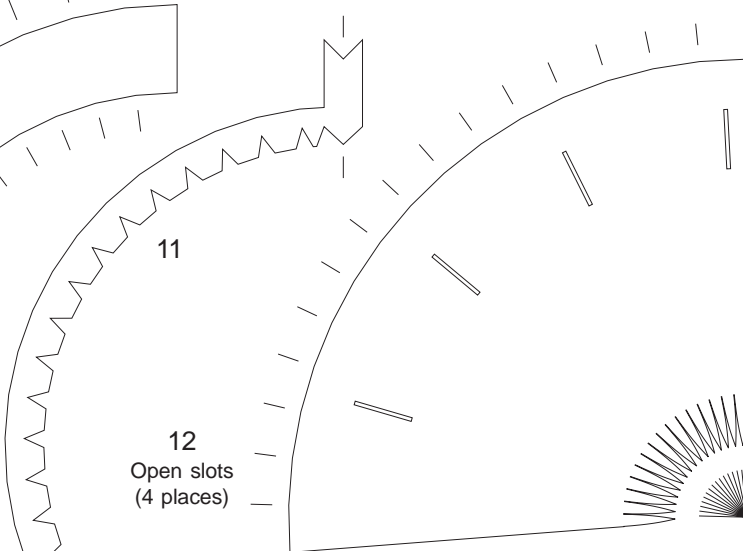
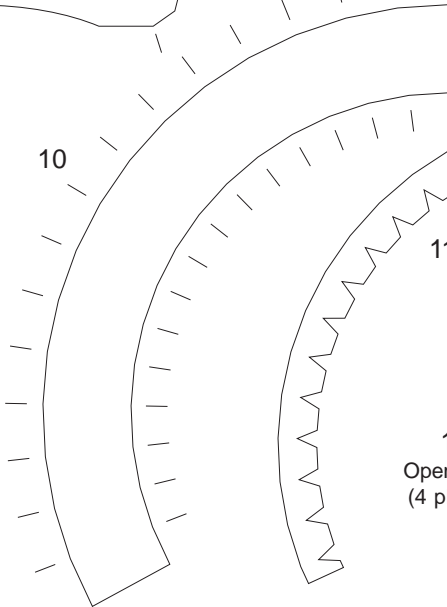
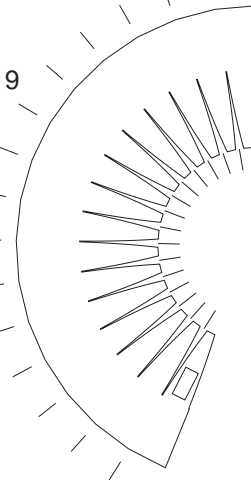

A

B

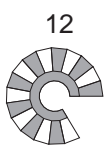
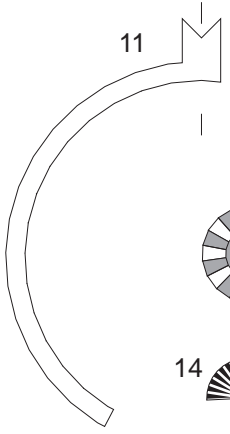
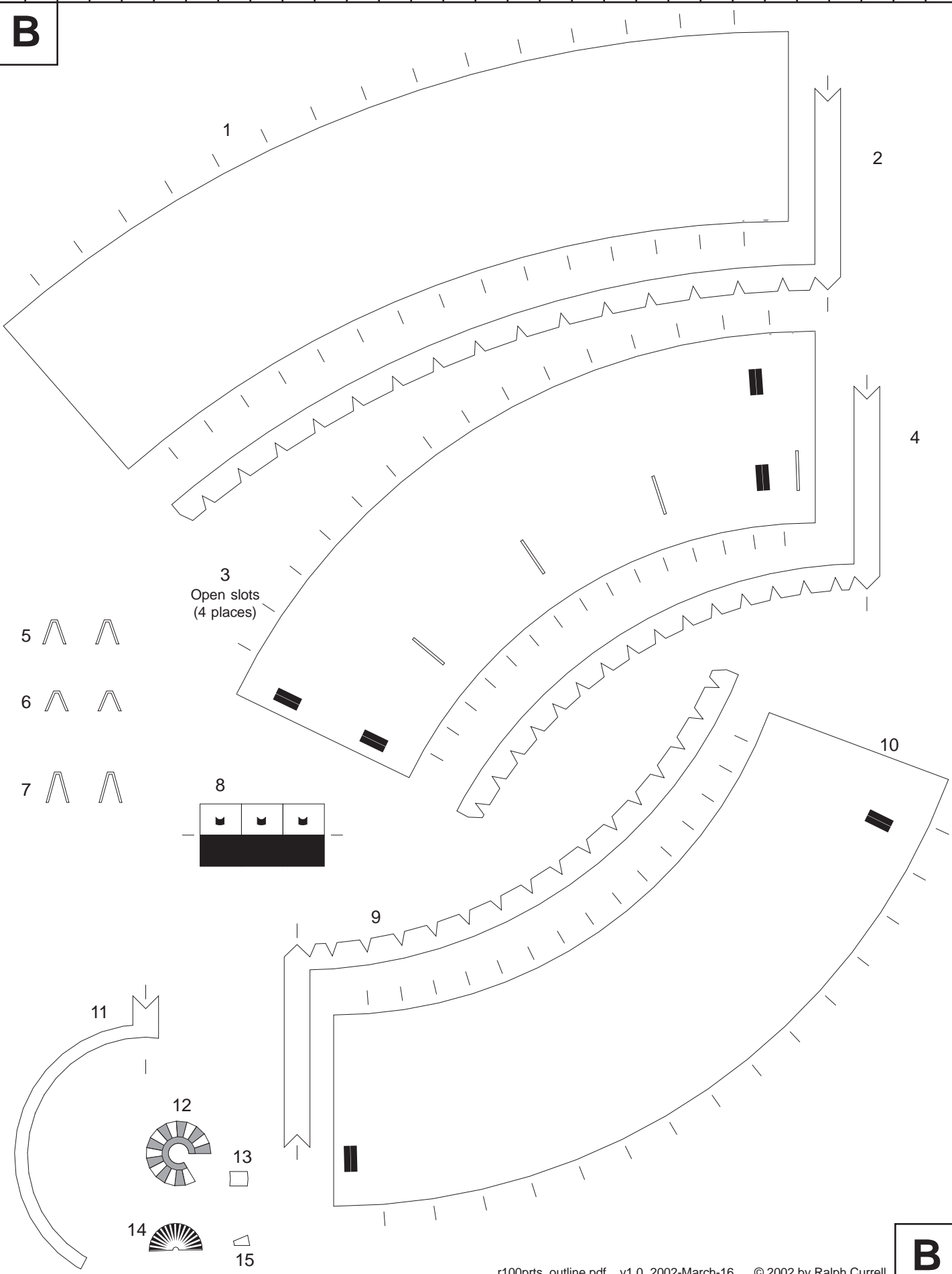

B

C

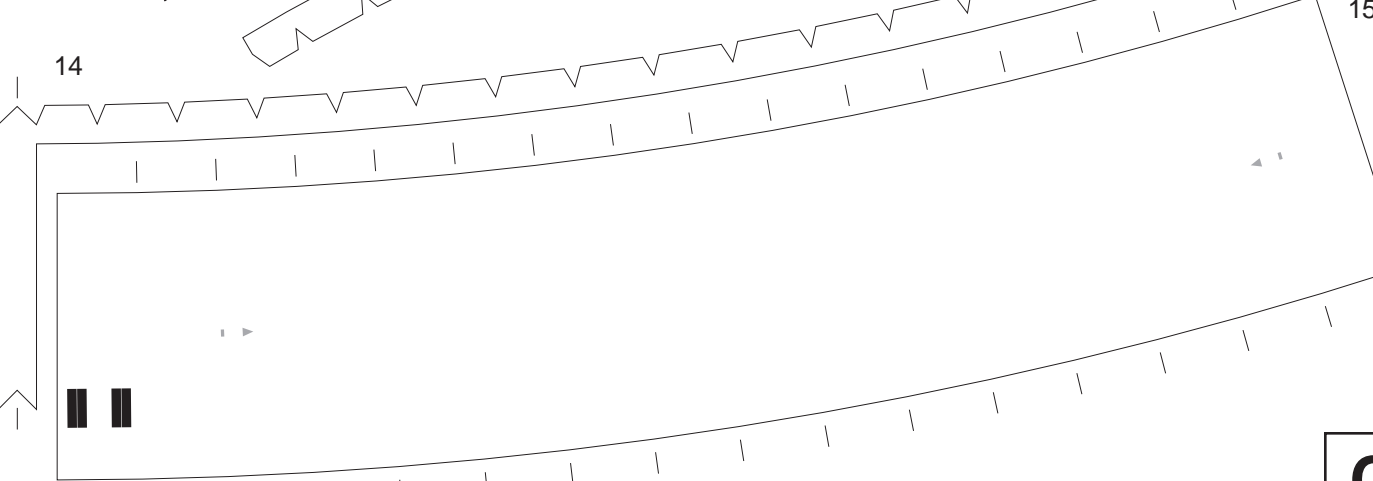
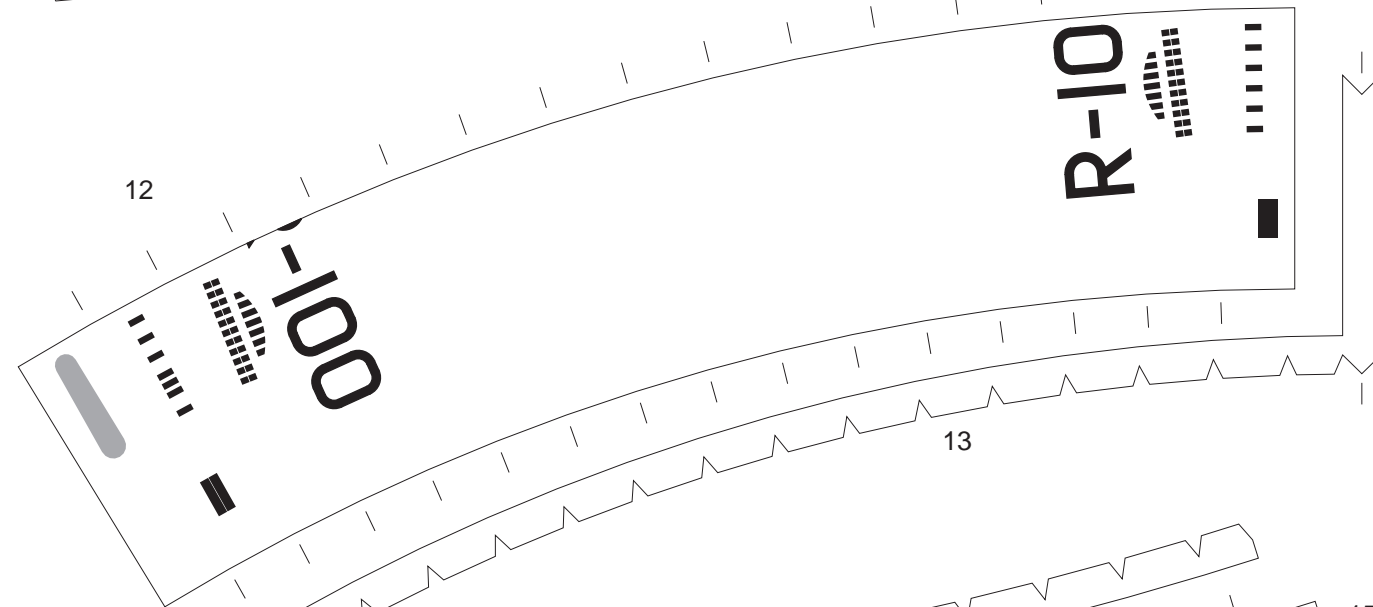
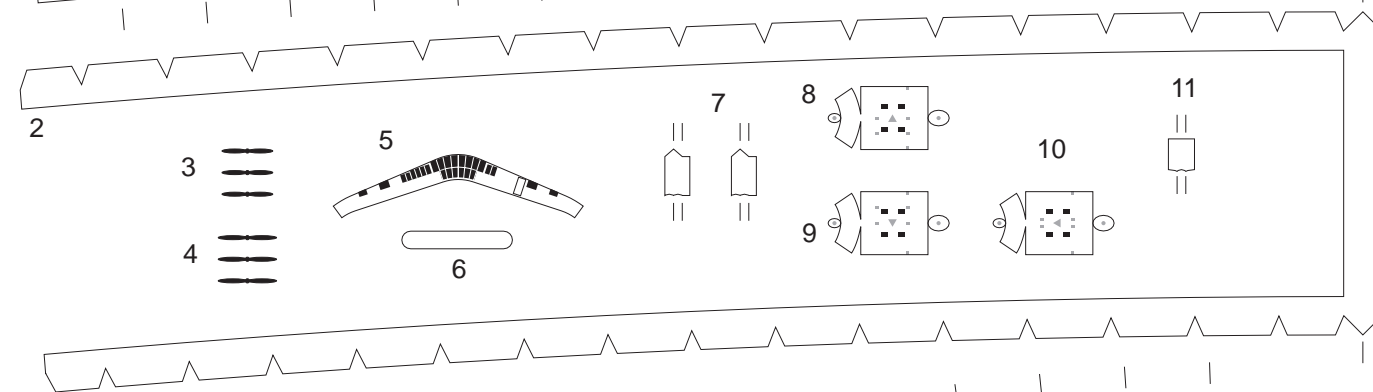
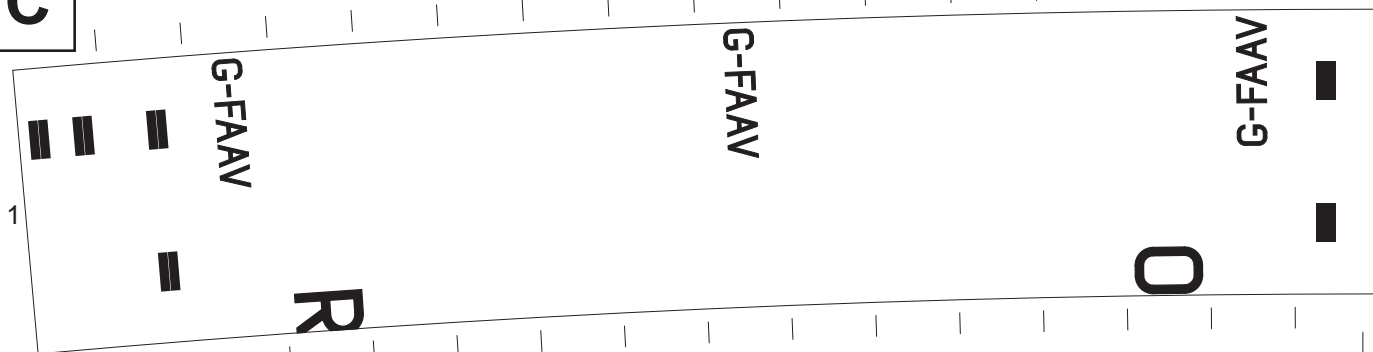

C

D

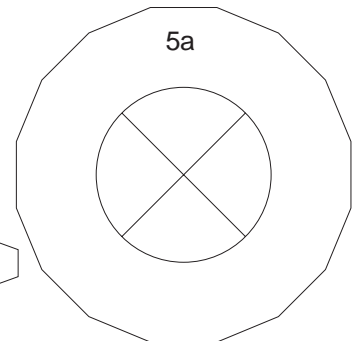
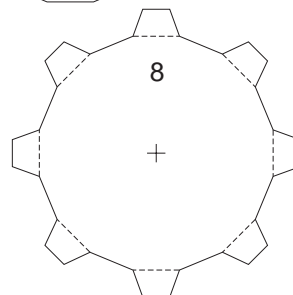
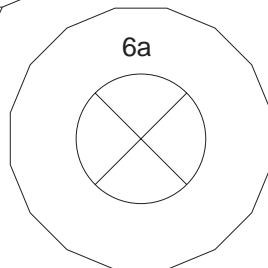
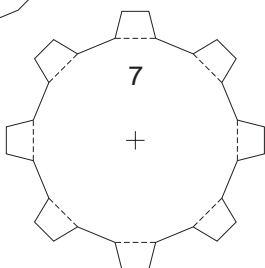
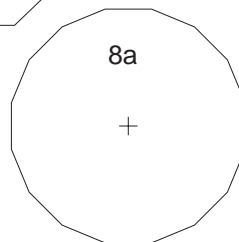
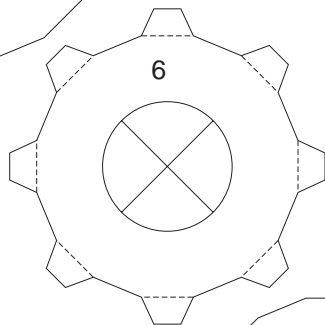
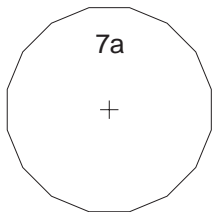
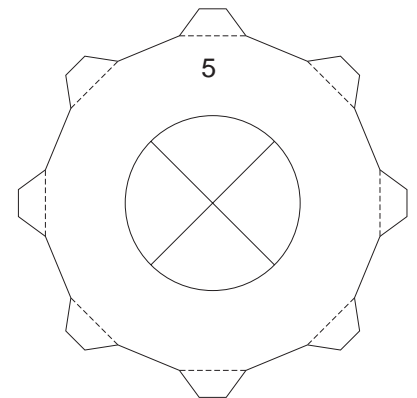
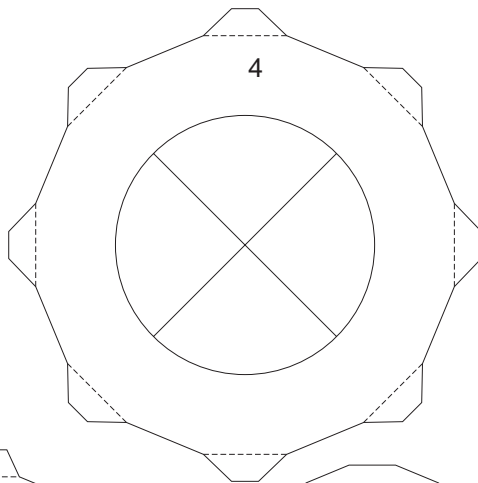
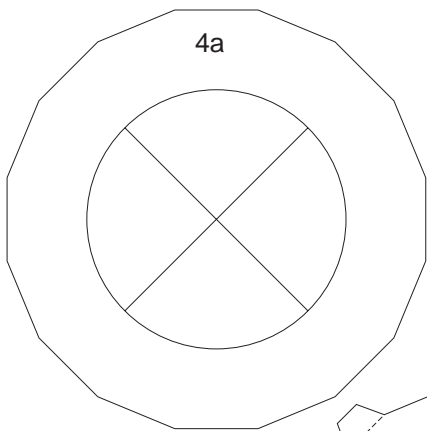
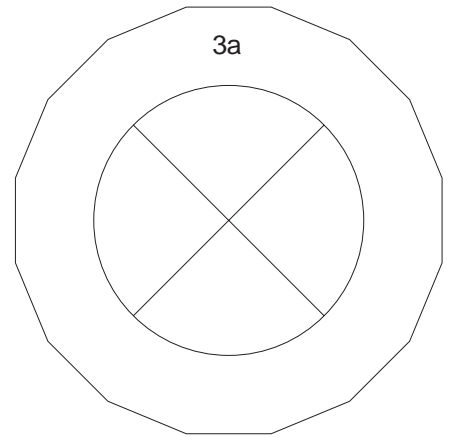
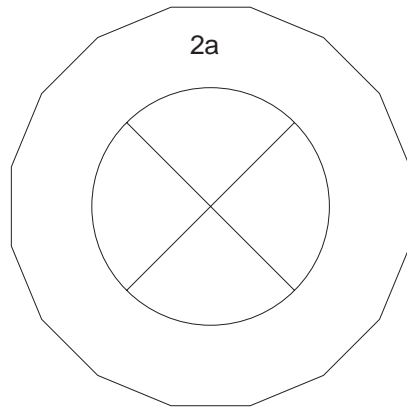
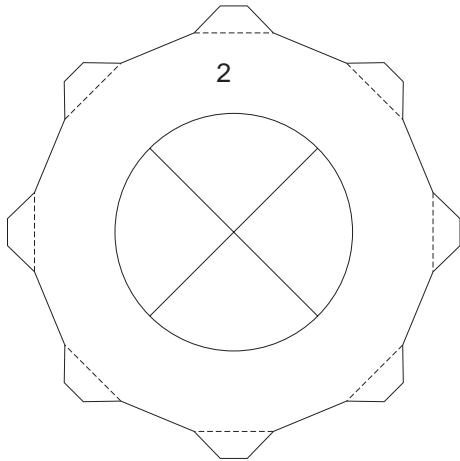
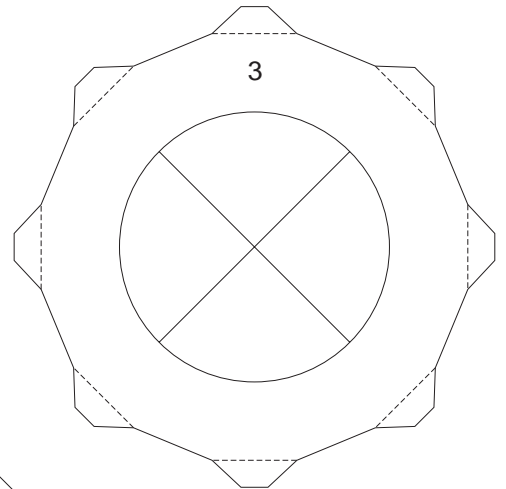
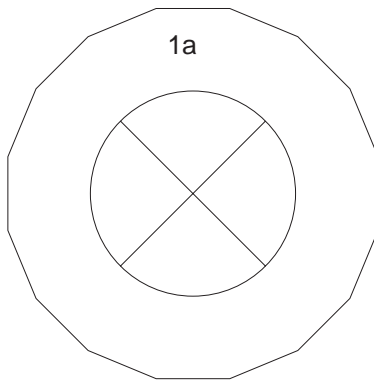
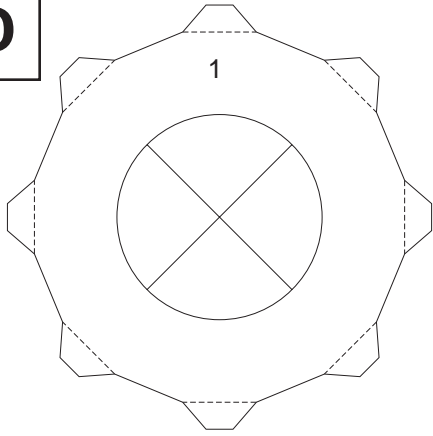

D