

A

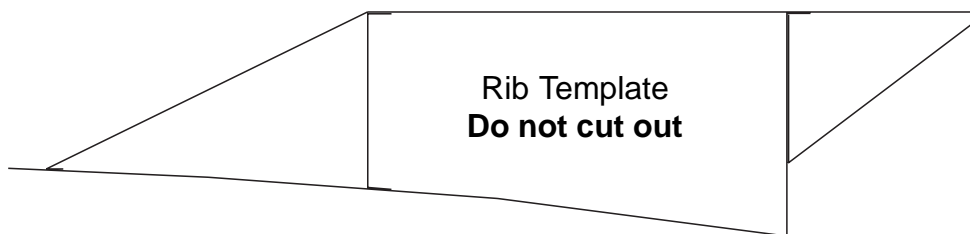

A

B

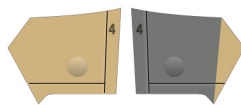
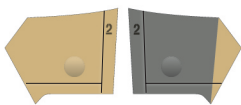
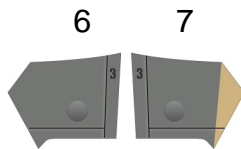
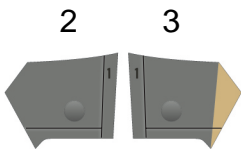
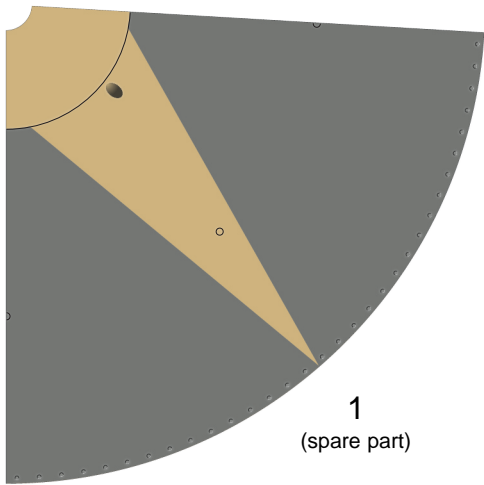
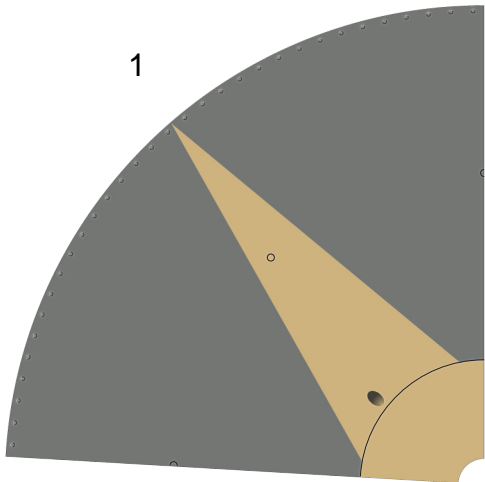
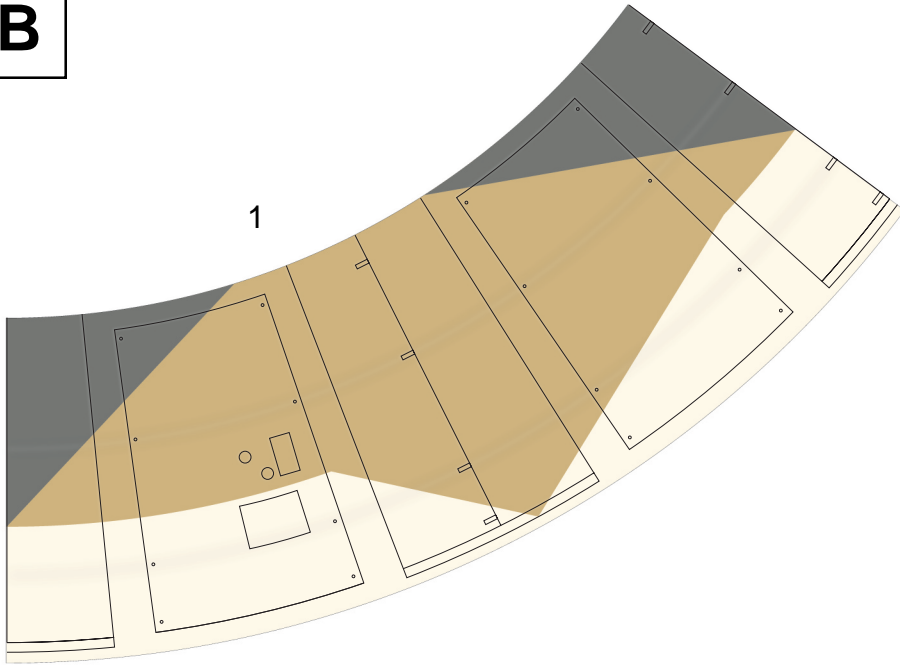

3

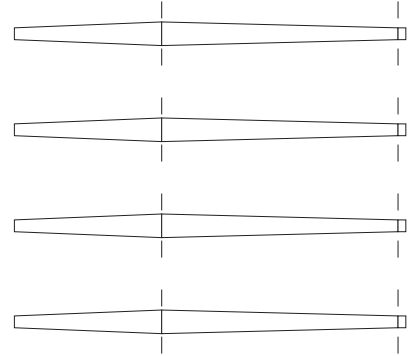

2

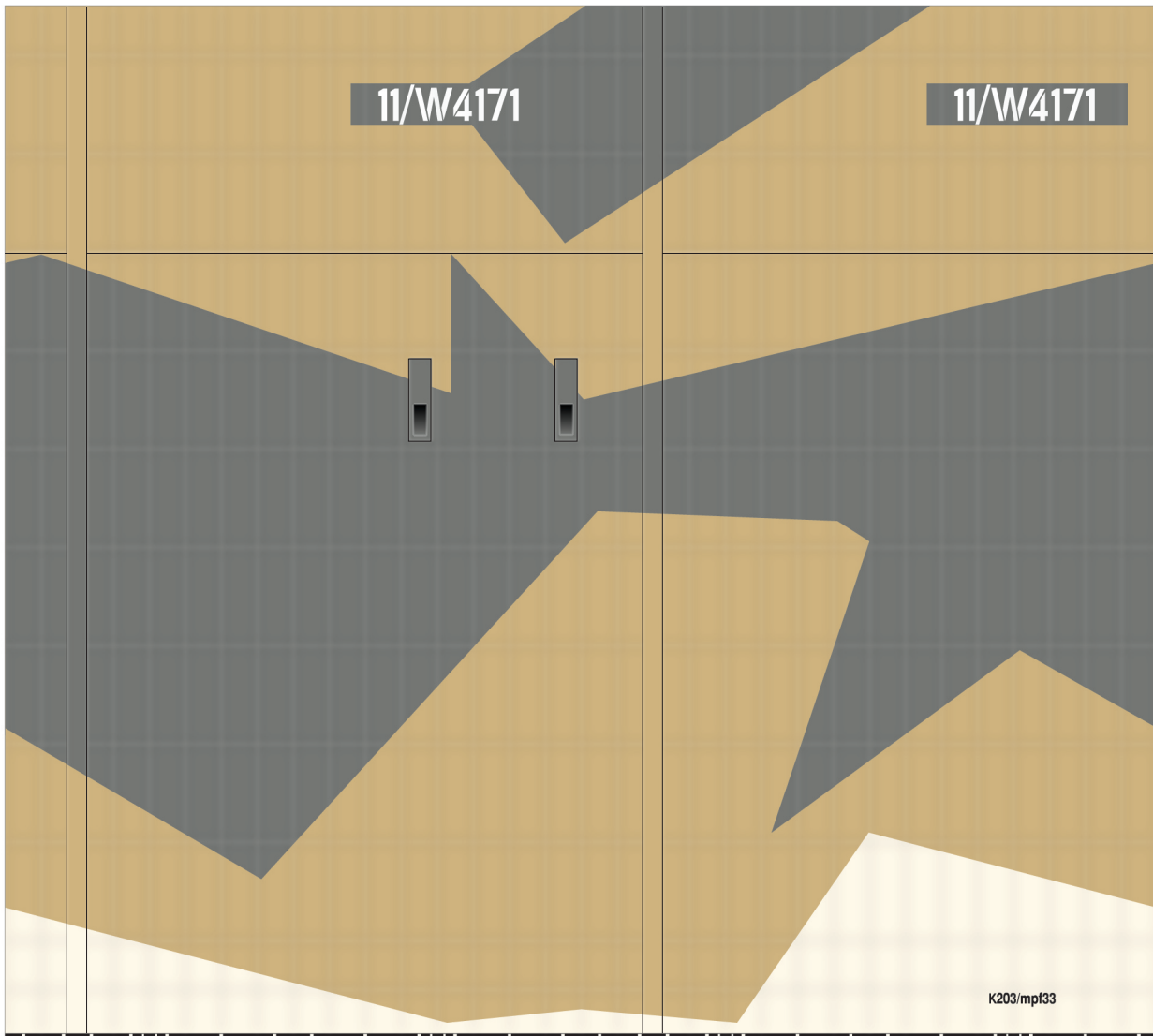

B

C

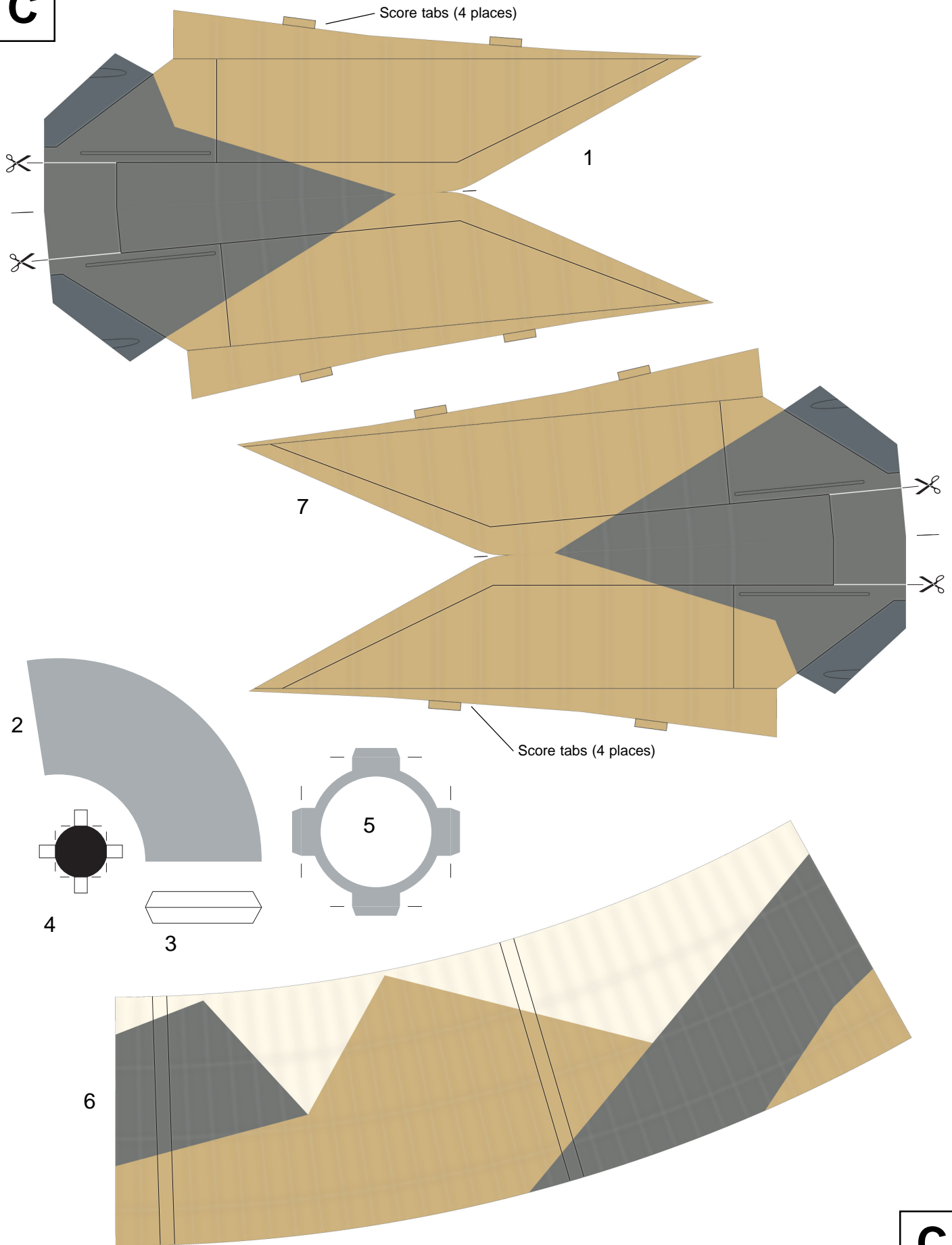

C

D

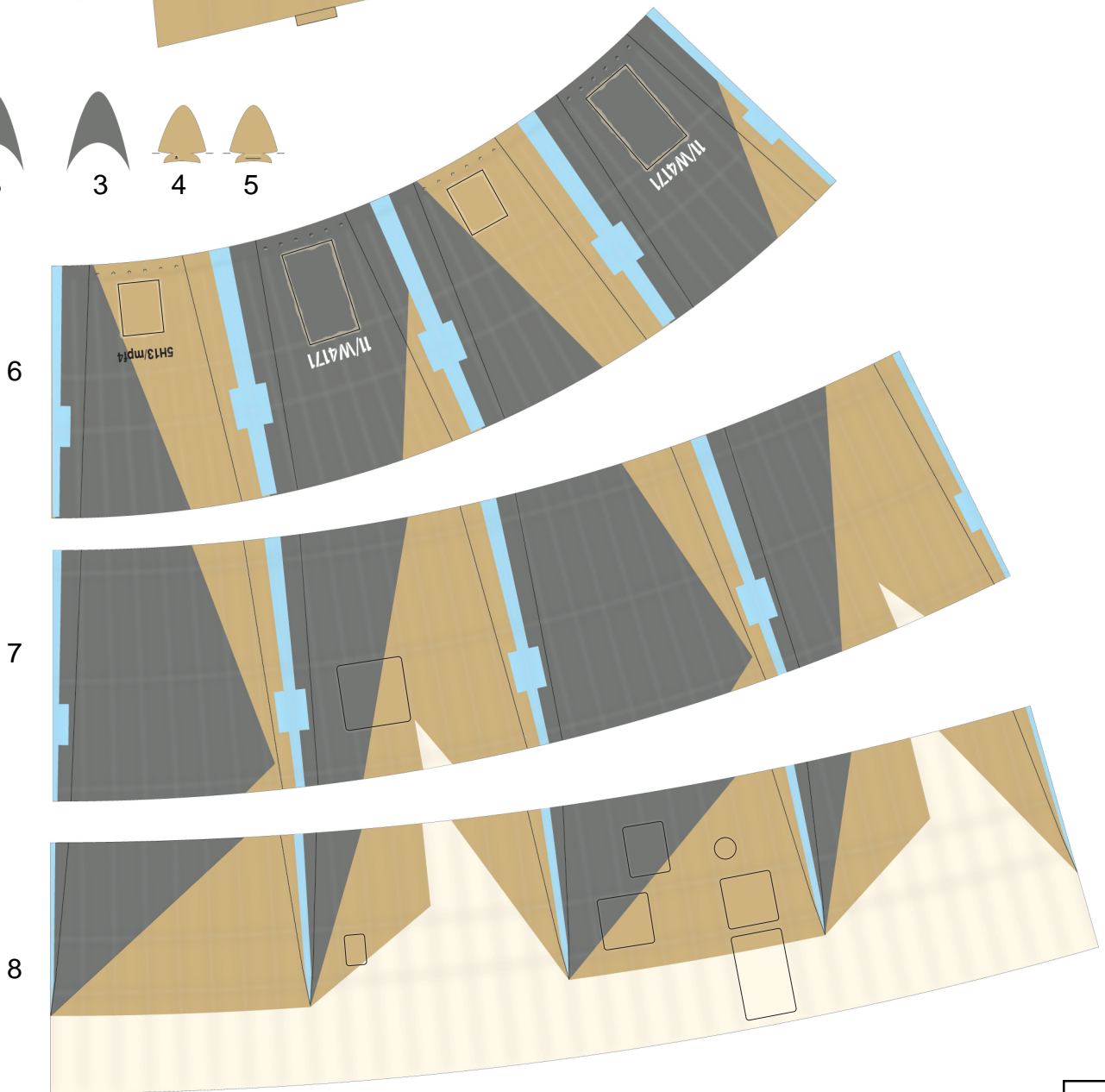
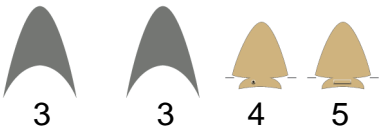
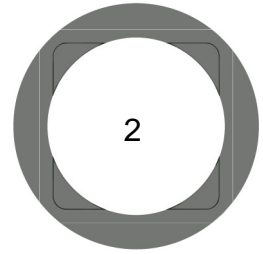
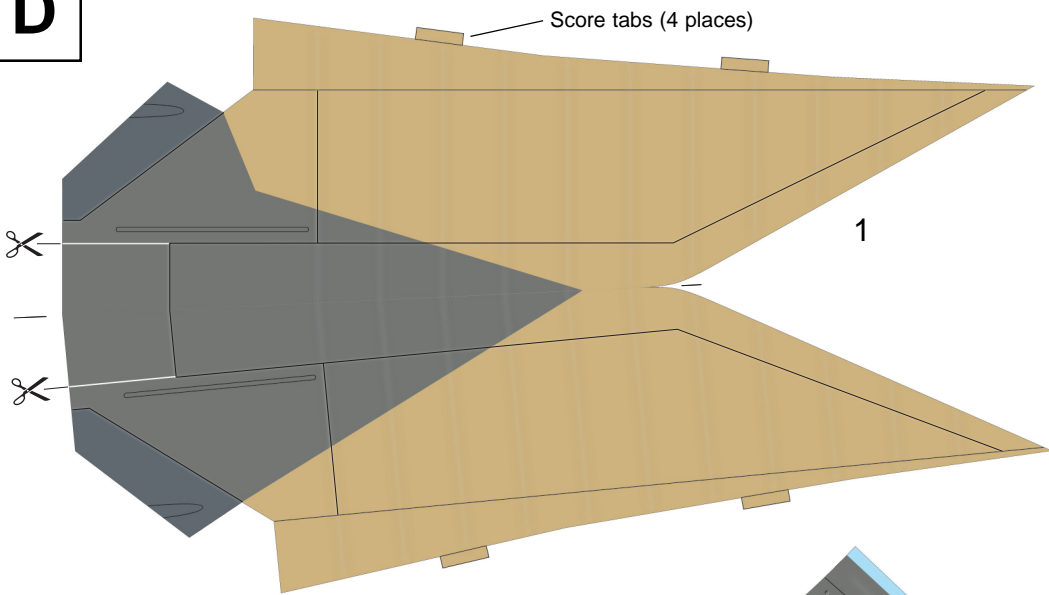

D

E

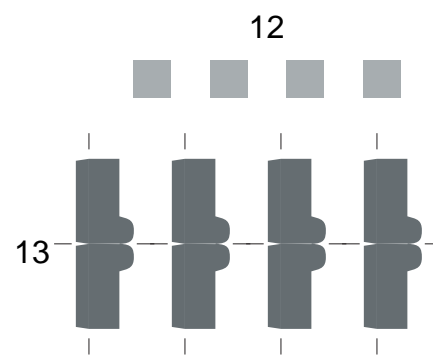
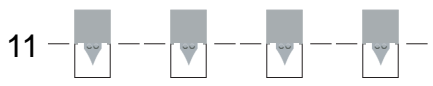
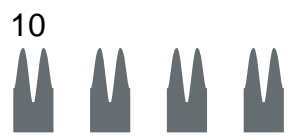
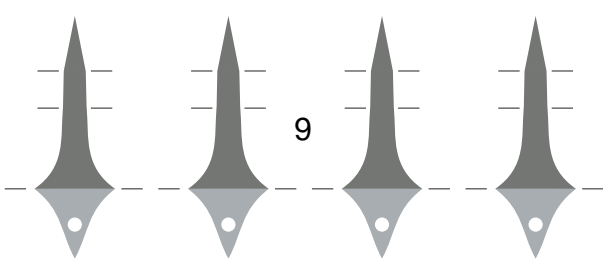
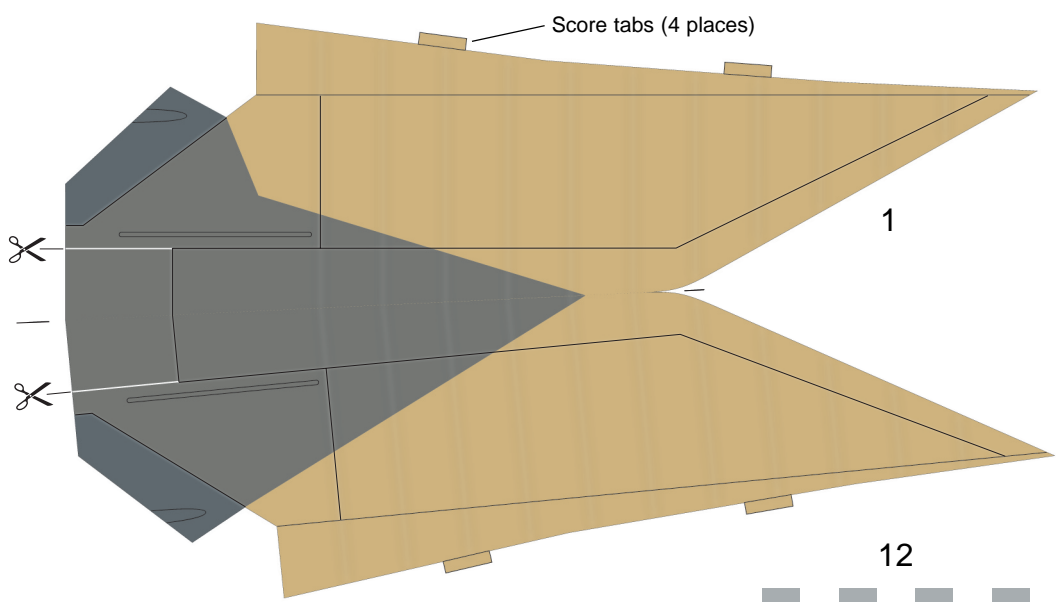
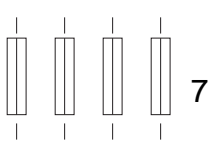
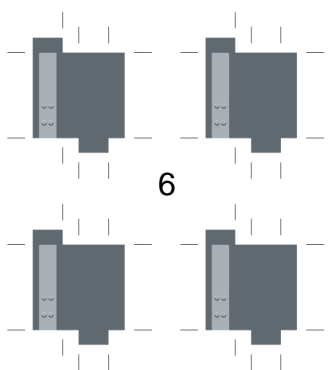
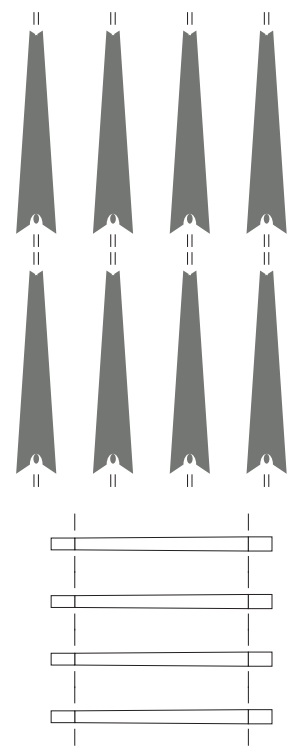
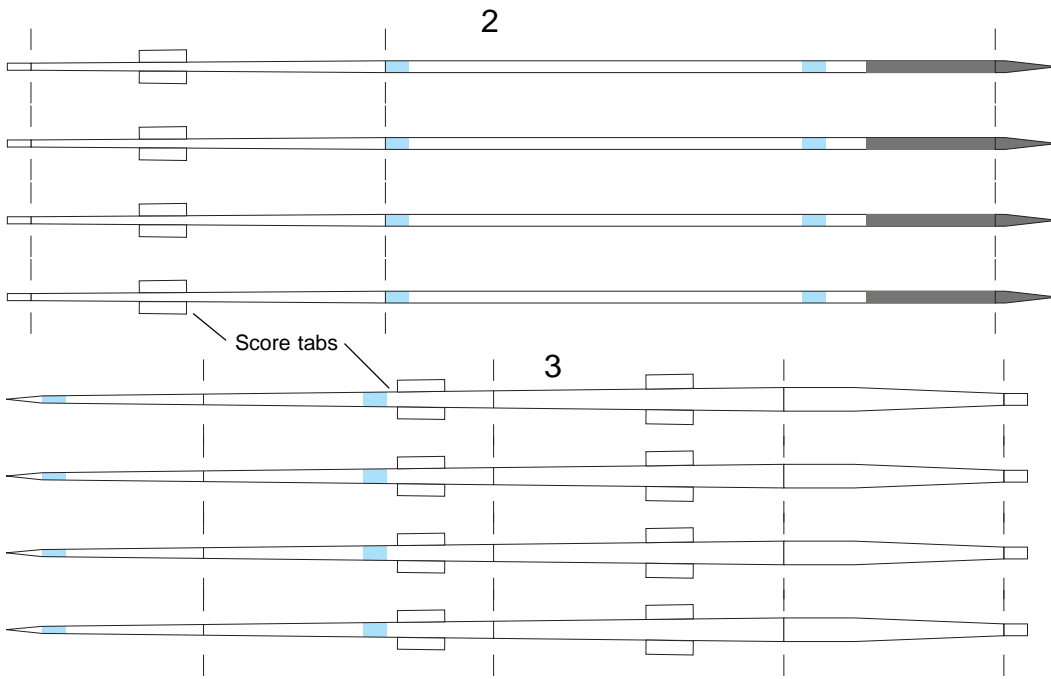

E

F

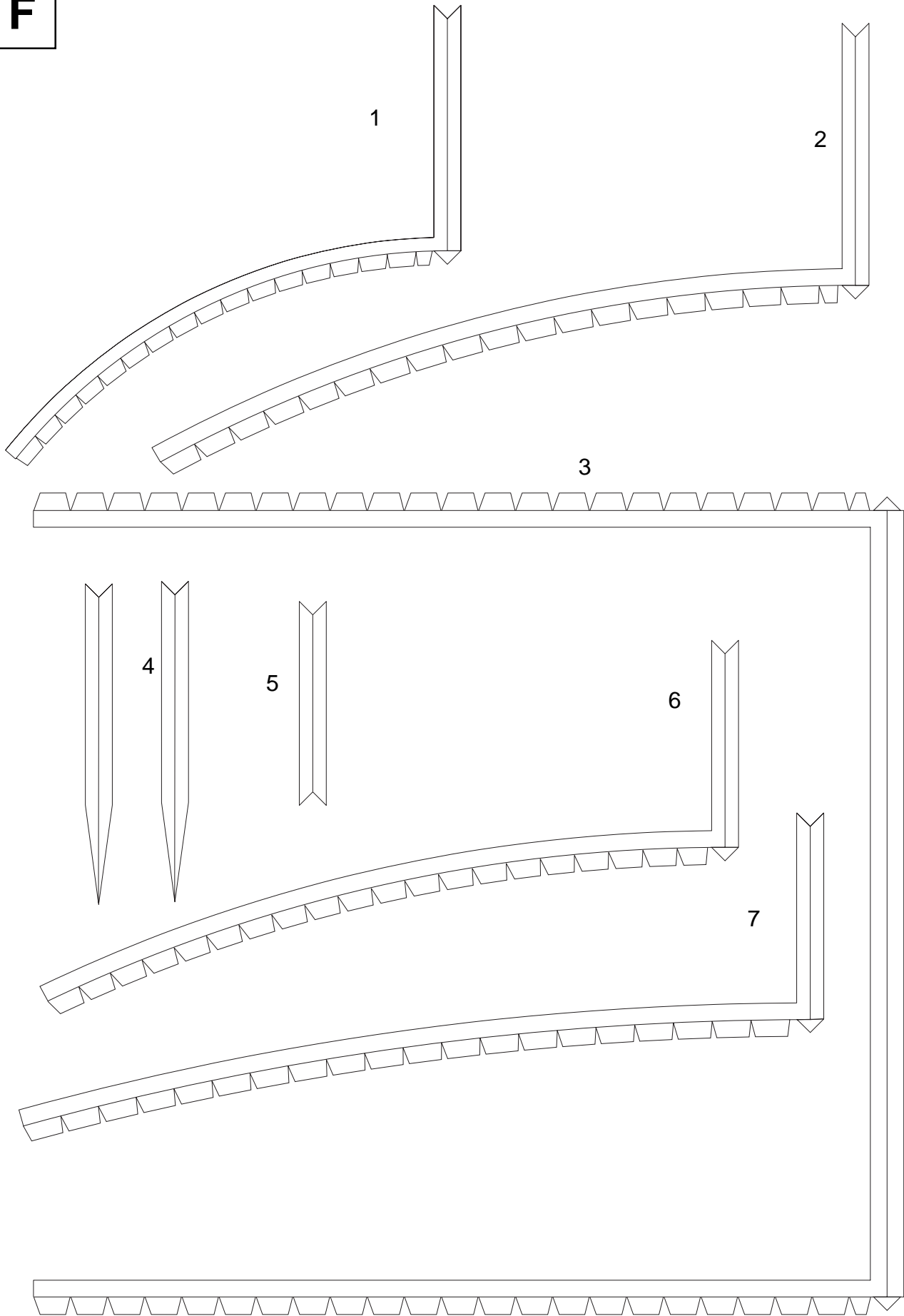

F

G

Score tabs before cutting.
Parts with "a" following number are
optional stiffeners.

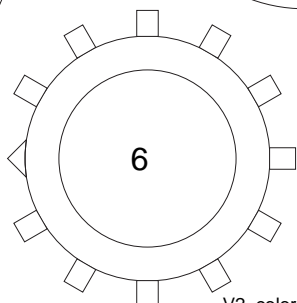
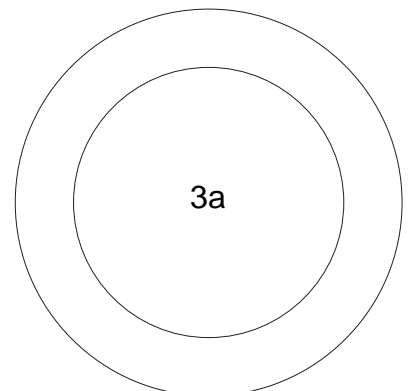
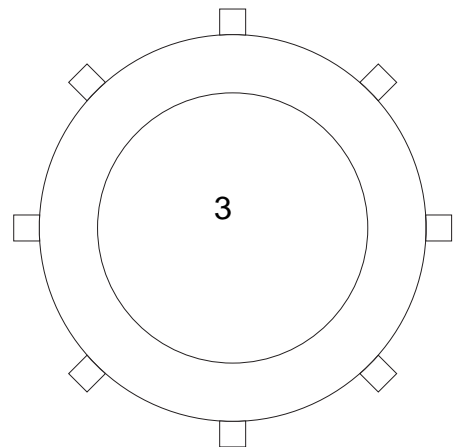
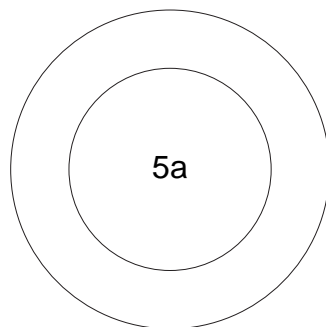
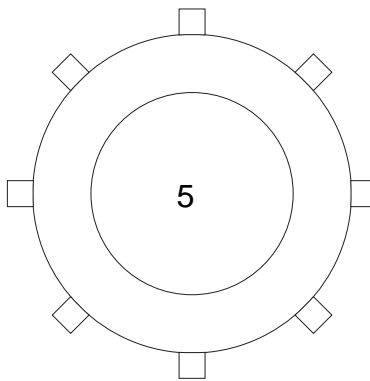
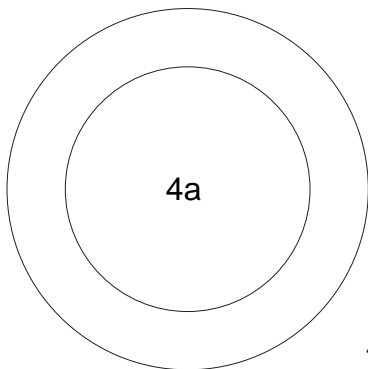
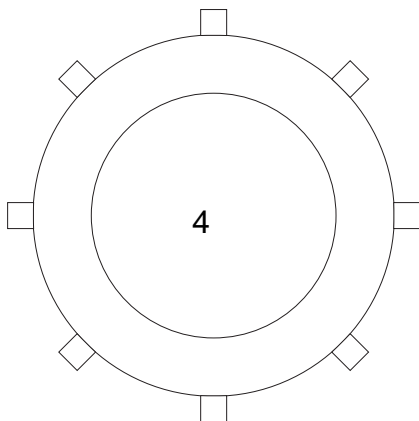
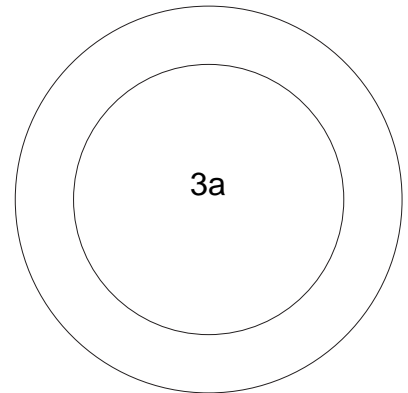
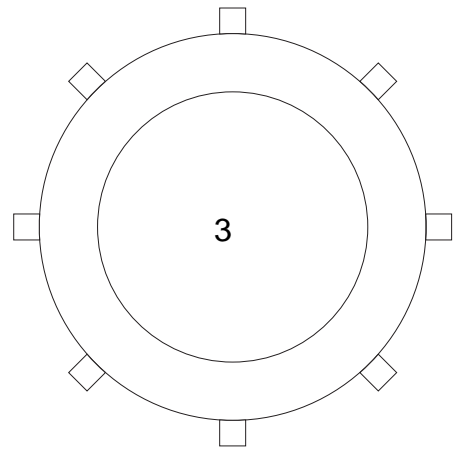
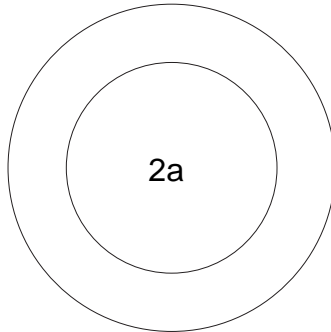
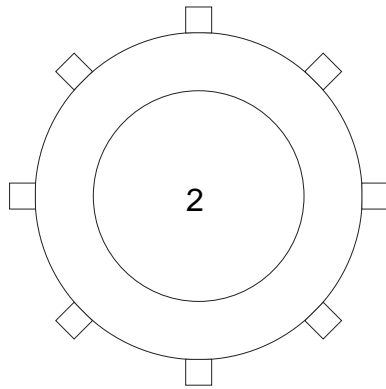
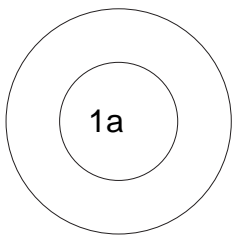
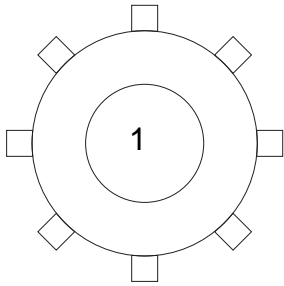
**G**