

A

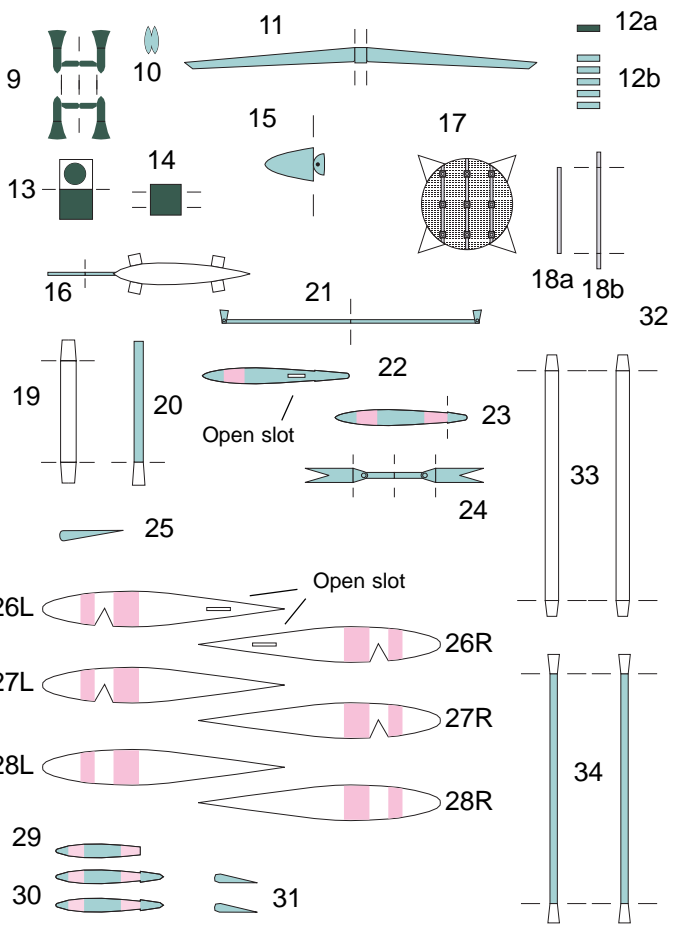
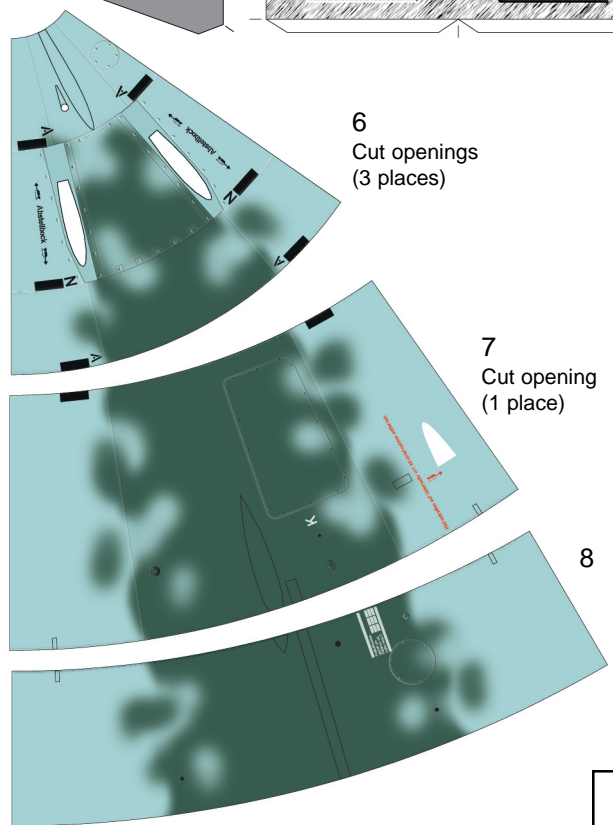
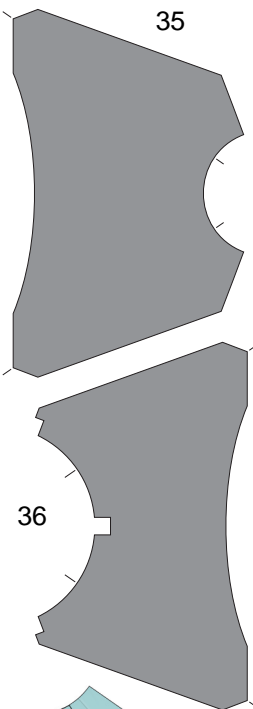
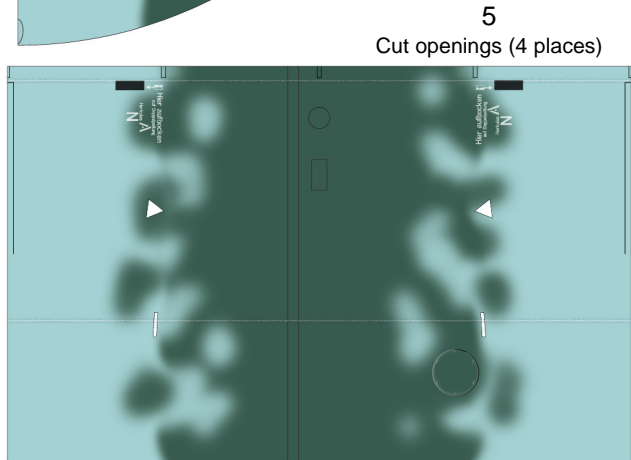
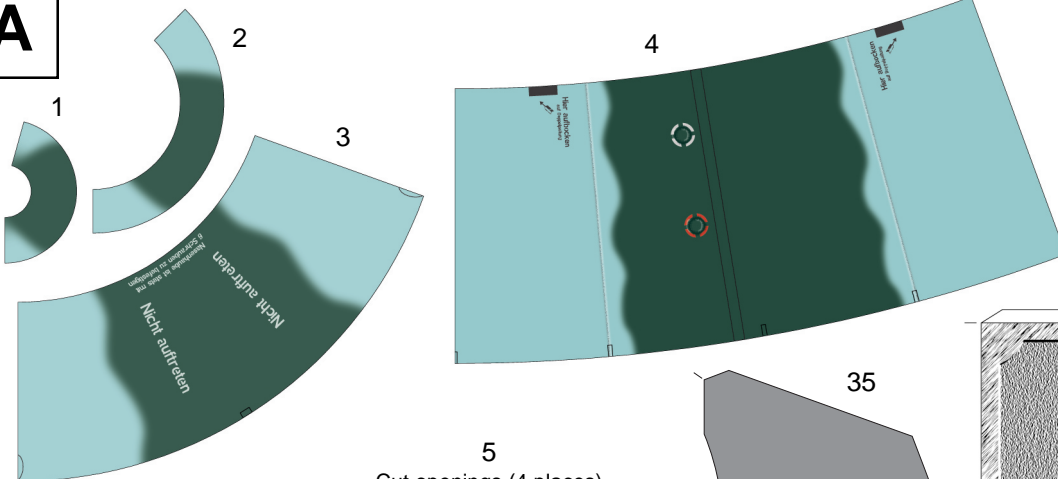

A

B

This page only: print reverse side using document v1b_back.pdf.
 Gray rectangle should correspond to parts B1 and B2.

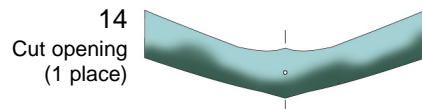
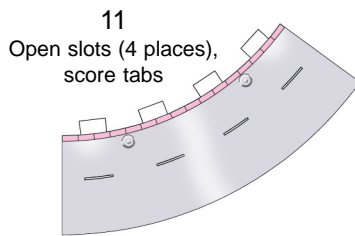
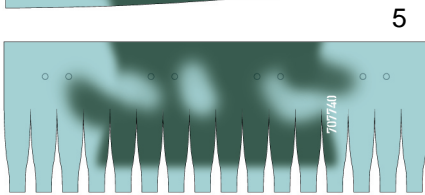
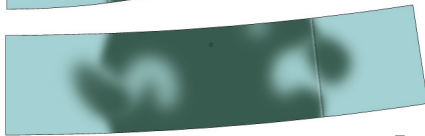
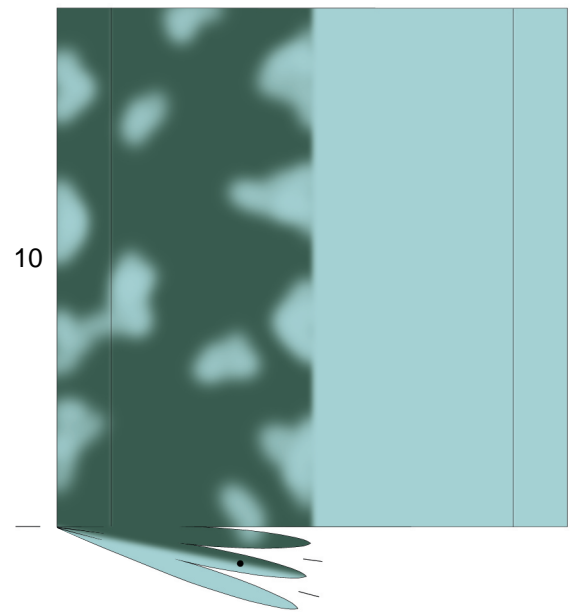
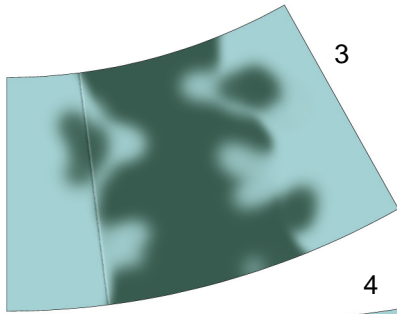
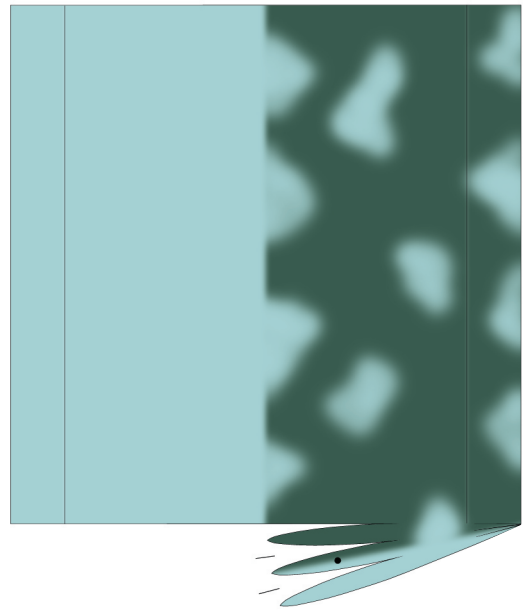
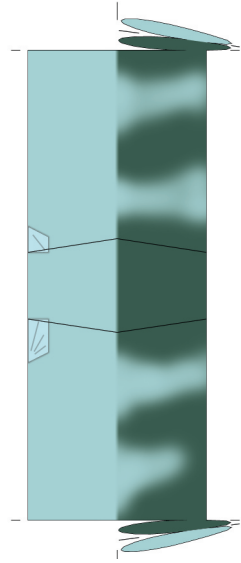
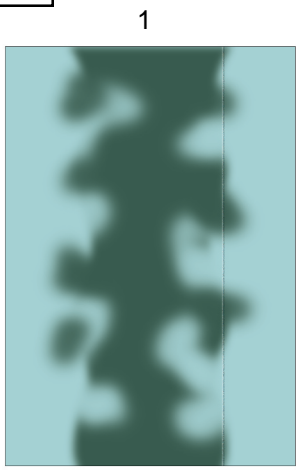

Curve guide for part B5
 Do not cut out

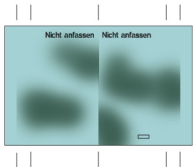

12

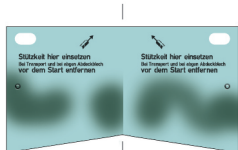

13
 Cut openings
 (2 places)

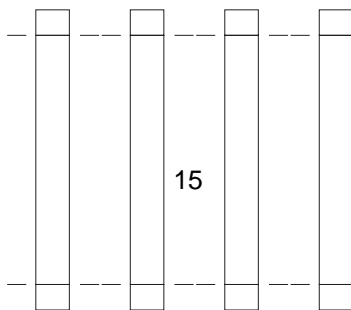

15

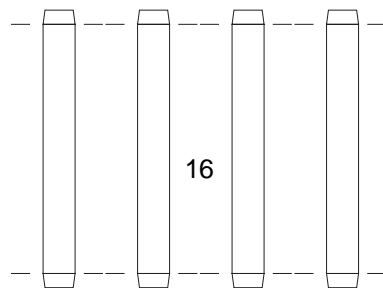

16

B

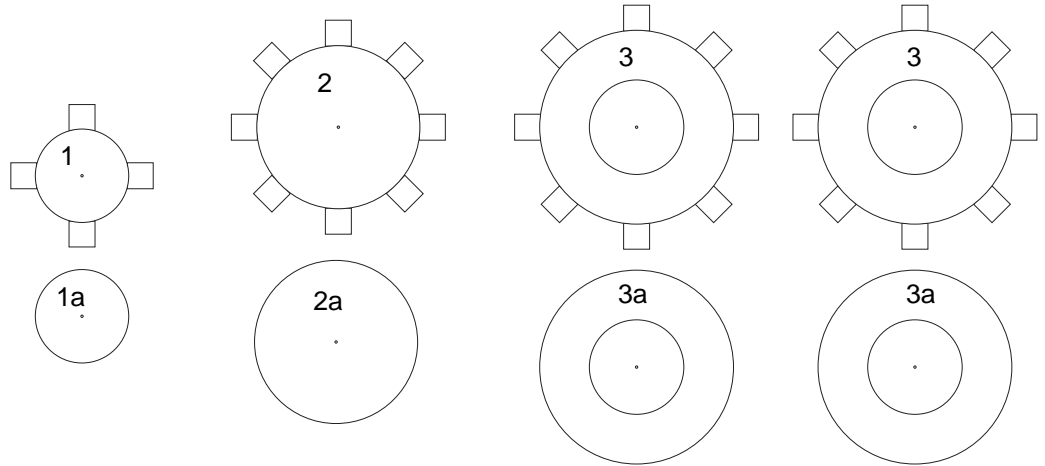
C

Parts 1–5, 18, 19: score tabs before cutting.
 Parts with “a” following number are stiffeners.

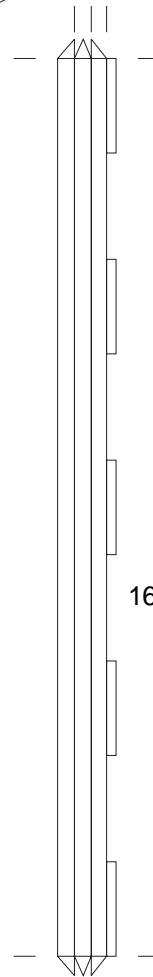
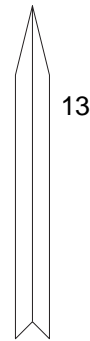
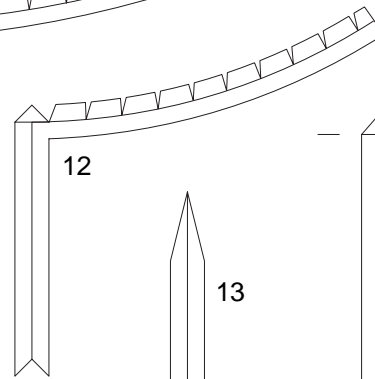
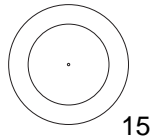
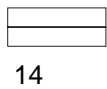
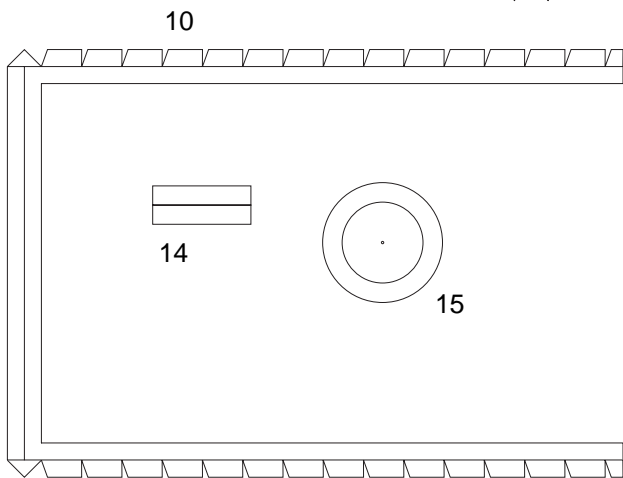
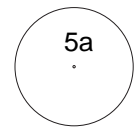
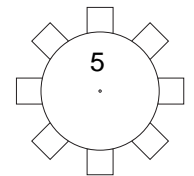
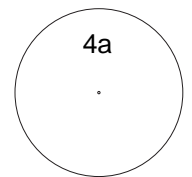
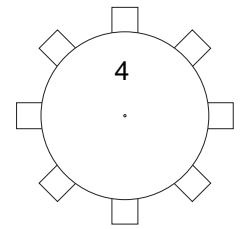
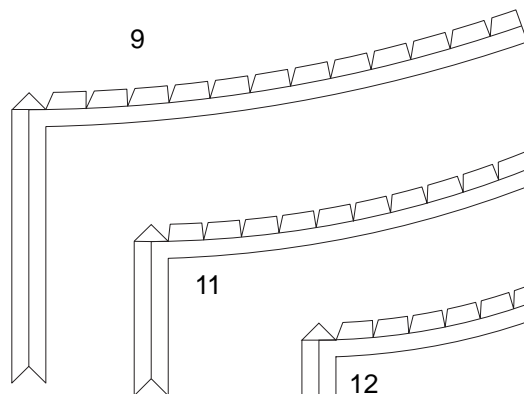
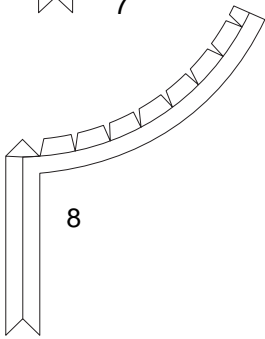
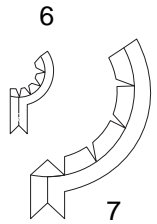

16

17

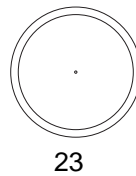
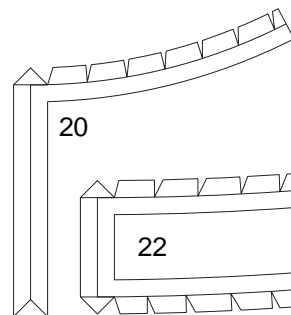
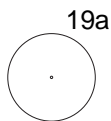
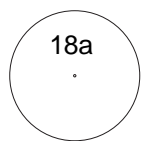
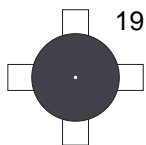
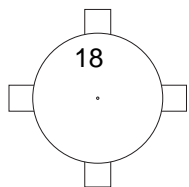
**C**