

SR400

PAPER CRAFT

Assembly Instructions



Thank you for downloading the "SR400" paper craft model. By simply following this manual while referring to the names and numbers shown on the parts sheets, you can assemble an authentic-looking replica of the SR400.

- Assembly instructions: Fifteen A4-sized sheets.
 - Paper craft: Seventeen A4-sized sheets with 223 parts in all
-

These instructions apply only to the "SR400." These Paper Craft parts are easier to work with when printed out on strong, thick paper (like postcard stock).

■ In creating these Paper Craft models we use 135kg Kent paper stock (0.18mm).

TO BEGIN

■ Tools and materials needed

-Ruler -Scissors - Blade cutter or "Exacto-knife" - Awl or other pointed tool (for making a folding crease) - Felt pen - Pin set - Glue - Hand towel (for cleaning your fingers) - Dictionary or other heavy book (to press the papers flat)

■ Items of Caution

*Take care when using sharp or pointed objects or when using bladed cutting tools. Place a heavy sheet of paper under the paper you want to cut.

*Use glue and other adhesives only in well-ventilated areas.

*When printing, use a slightly reduced font size as there are many differences in dimensions depending on the type of printer used.

HOW TO ASSEMBLE

*Follow the working method and markings carefully.

*Cut carefully along the outer line with a cutting blade, Exacto-knife or scissors.

One - point Advice

*Cut carefully with a cutting blade, Exacto-knife or scissors.

*For folding parts, first use an awl or other pointed tool to make a light crease along the dotted or solid line. This will make the folds straight. Avoid making strong creases, as this will cause the paper to tear.

*As an adhesive, white wood glue is recommended. Avoid over-application as this will cause the paper to wrinkle.

*Before beginning assembly, test adhesive amounts on extra paper.

*Occasionally, white spots will be apparent on folds and cuts. Use a marker or pencil to fill-in these spots. It is recommended that this be done after each stage of assembly because coloring becomes more difficult once parts are assembled.

Basic working method and markings

Solid lines

Fold along these lines. The printed surface should be on the outside of the folded shape.

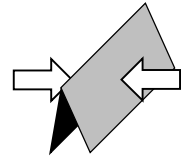

Broken lines

Fold along these lines. The printed surface should be on the inside of the folded shape.

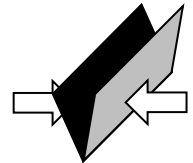

Dotted line

Cut along these lines

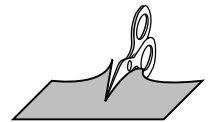

Do not fold or cut the parts marked .

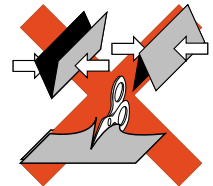

Cut out parts marked with an asterisk (*).

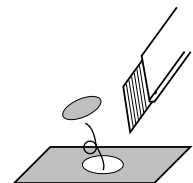

Red dots are the reference positions for gluing surfaces.

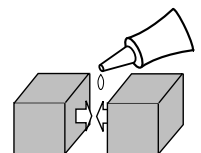

1 Assembling the Fuel Tank & Seat

First, assemble each component by following the working method and markings. Then, refer to the illustration and photos below to glue the parts together.

Indication of Working Methods



Fold or Curve



Glue

Fuel Tank

Sheet A, 5 parts in total

Fold each relevant part according to the assembly symbols.

Please use the ● dots on each component as reference when gluing surfaces.

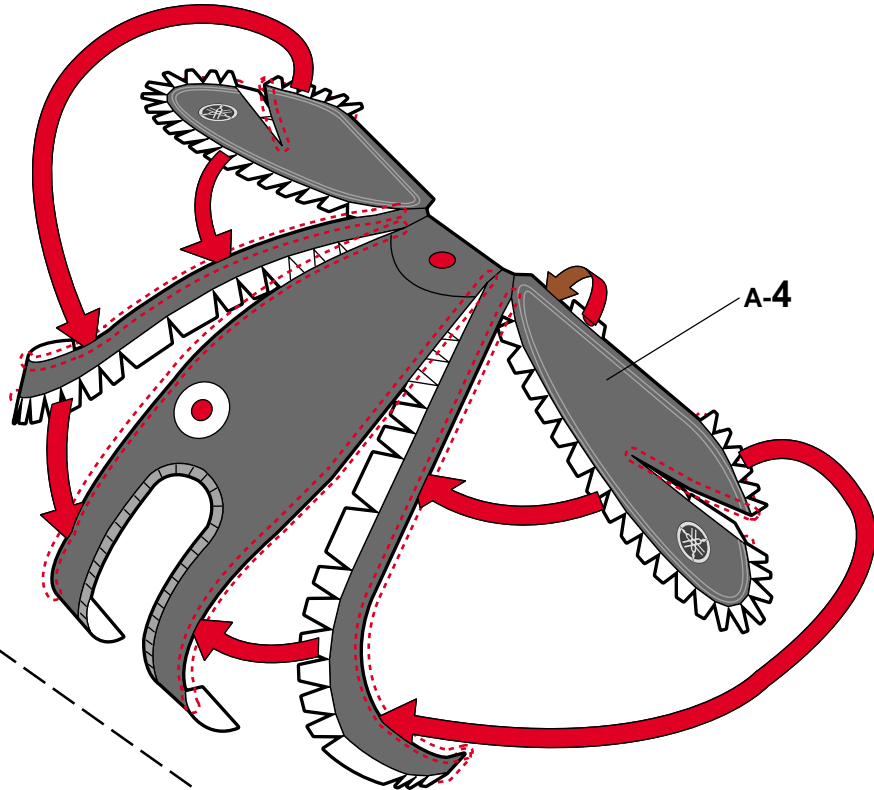

Fold and glue the corresponding tabs (dotted parts) so that they make good symmetrical pairs.

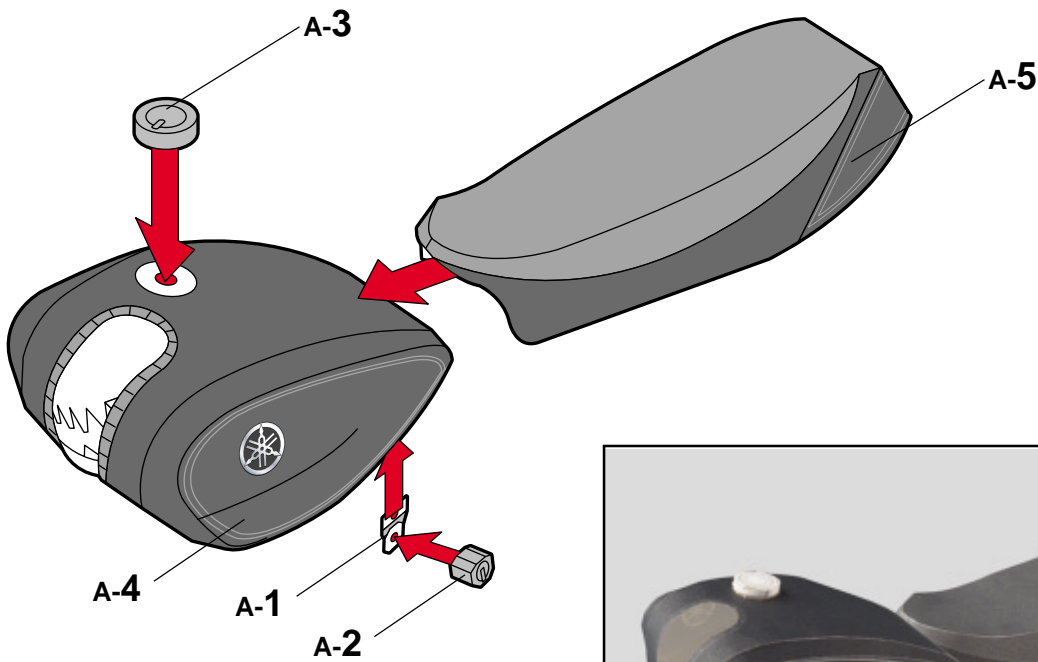

Reference photo



2 Assembling the Steering

First, assemble each component by following the working method and markings. Then, refer to the illustration and photos below to glue the parts together.

Indication of Working Methods

 Fold or Curve  Glue

Steering

Sheet B, 39 parts in total

Fold each relevant part according to the assembly symbols.

Please use the ● dots on each component as reference when gluing surfaces.

[Upper Steering Column]

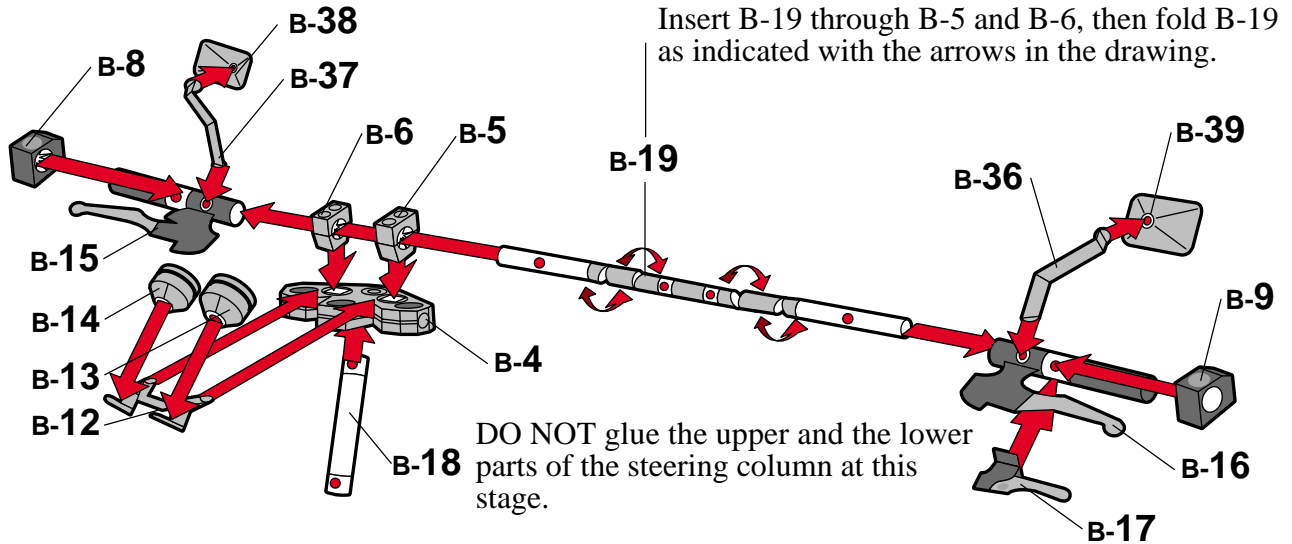

[Lower Steering Column]

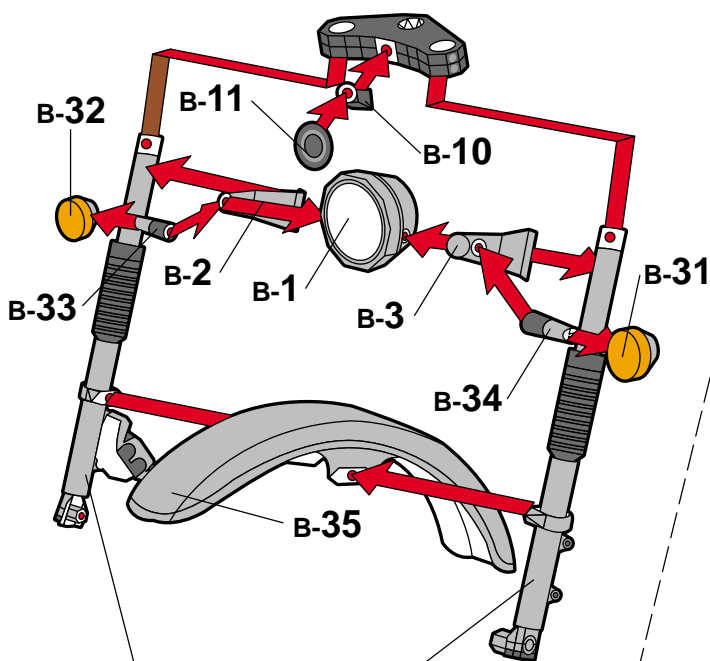

[Front Fork]

[Telescopic Front Fork]

Assemble both forks. The diagram shows how the right front fork looks. The numbers within the parentheses indicate the parts for the left front fork.

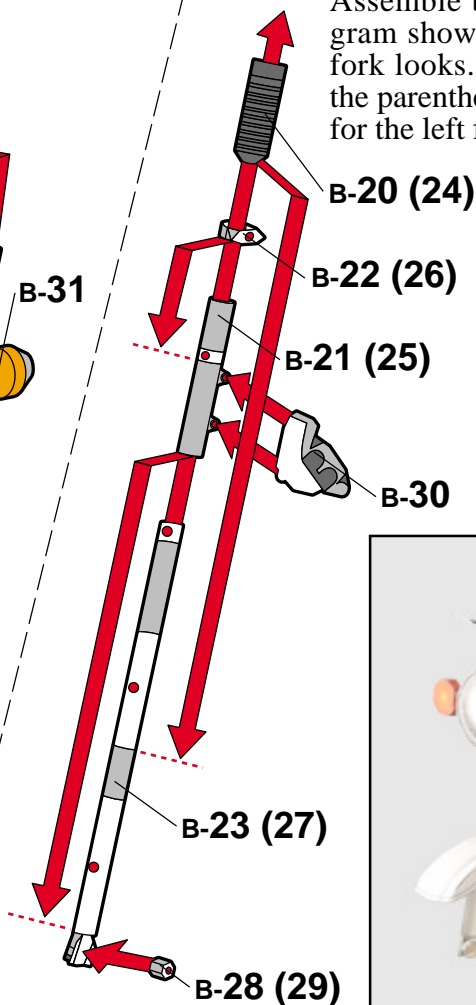

Reference photo

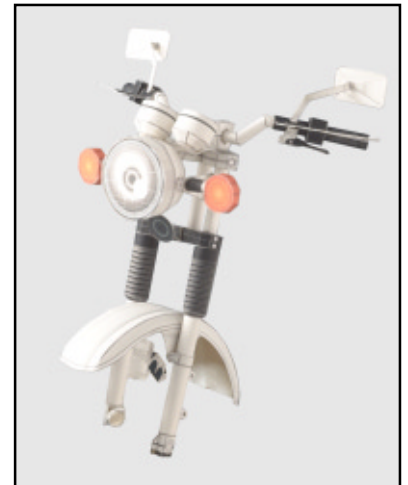

3 Assembling the Frame -A

First, assemble each component by following the working method and markings. Then, refer to the illustration and photos below to glue the parts together.

Indication of Working Methods

 Fold or Curve  Glue

Frame

Sheet C, 78 parts in total

Fold each relevant part according to the assembly symbols.

Please use the ● dots on each component as reference when gluing surfaces.

1

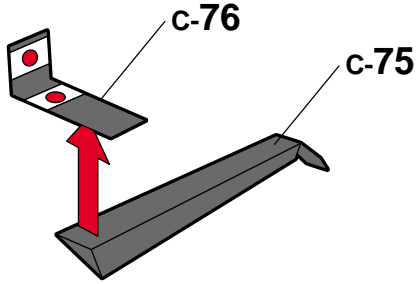

2

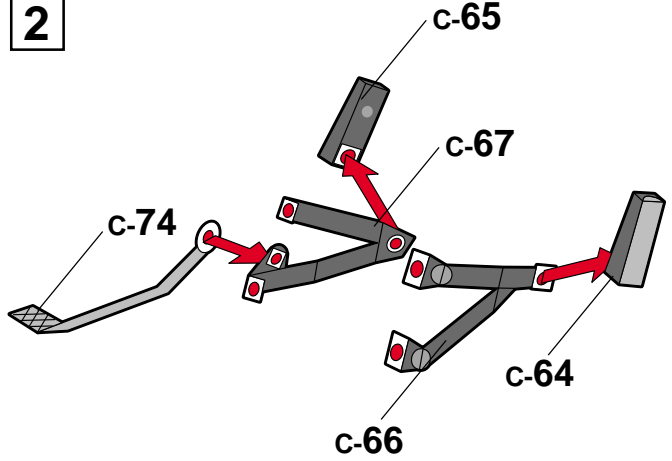

3

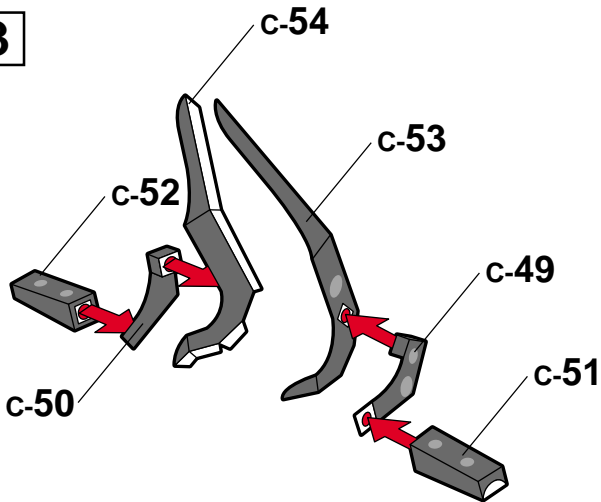

4

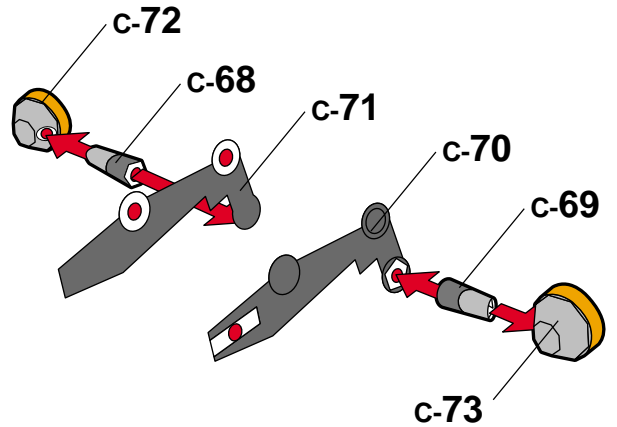

5

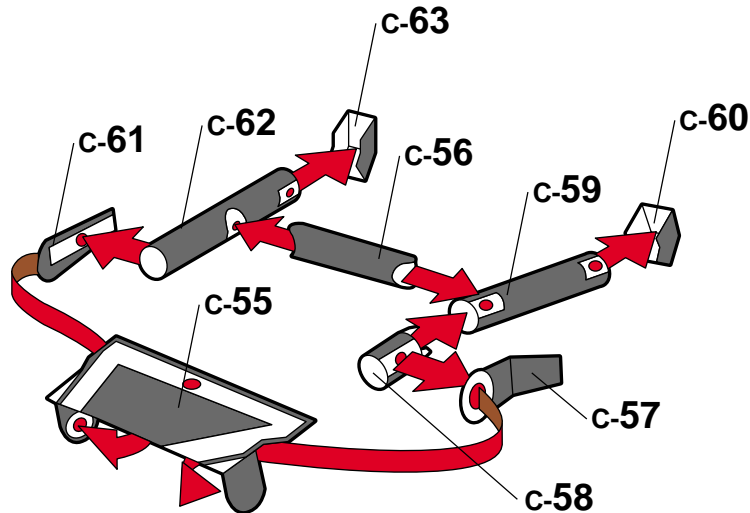

3 Assembling the Frame -B

First, assemble each component by following the working method and markings. Then, refer to the illustration and photos below to glue the parts together.

Indication of Working Methods

 Fold or Curve  Glue

Frame

Sheet C, 78 parts in total

Fold each relevant part according to the assembly symbols.

Please use the ● dots on each component as reference when gluing surfaces.

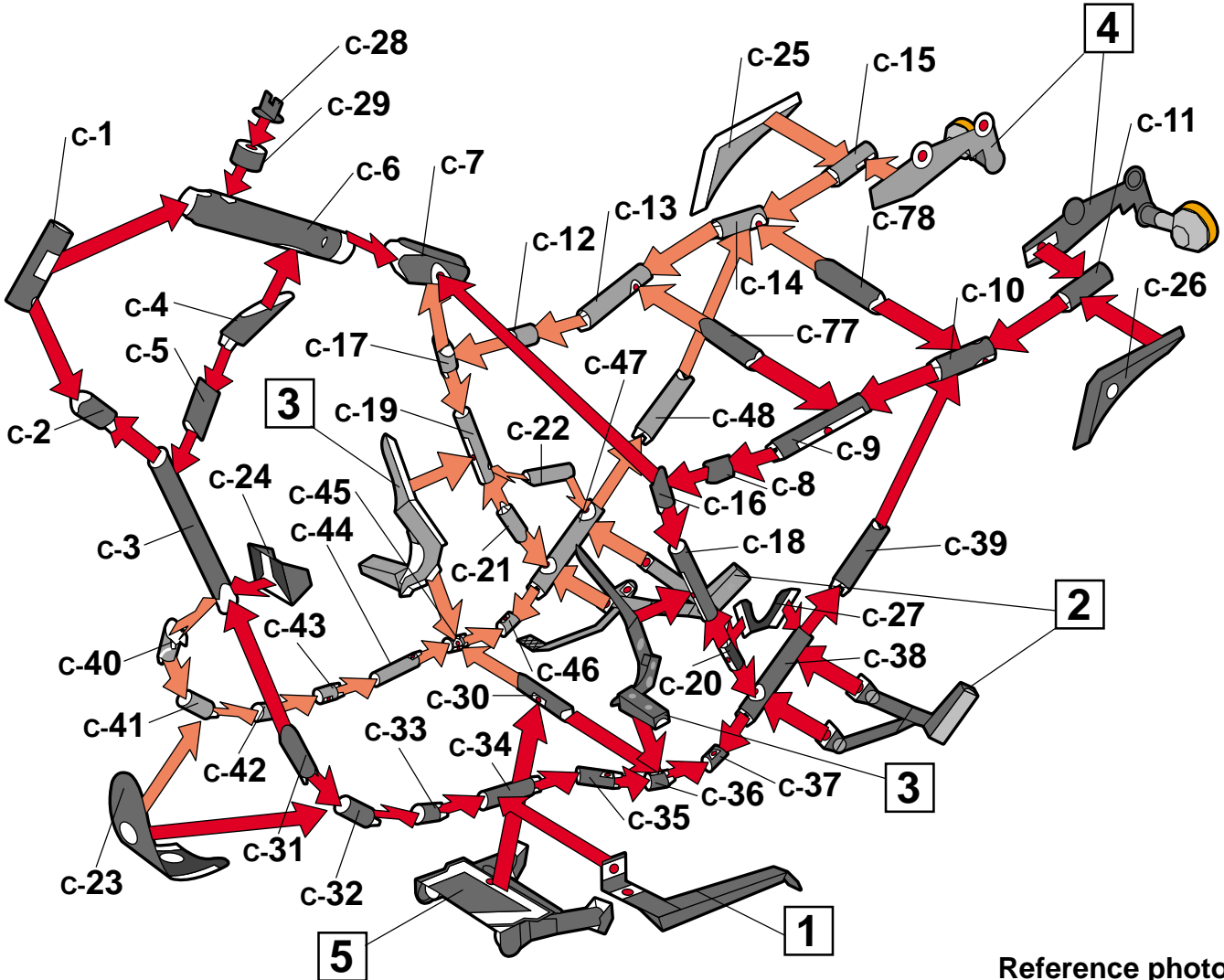

Reference photo



4 Assembling the Engine

First, assemble each component by following the working method and markings. Then, refer to the illustration and photos below to glue the parts together.

Indication of Working Methods

 Fold or Curve  Glue

Engine

Sheet D, 24 parts in total

Fold each relevant part according to the assembly symbols.

Please use the ● dots on each component as reference when gluing surfaces.

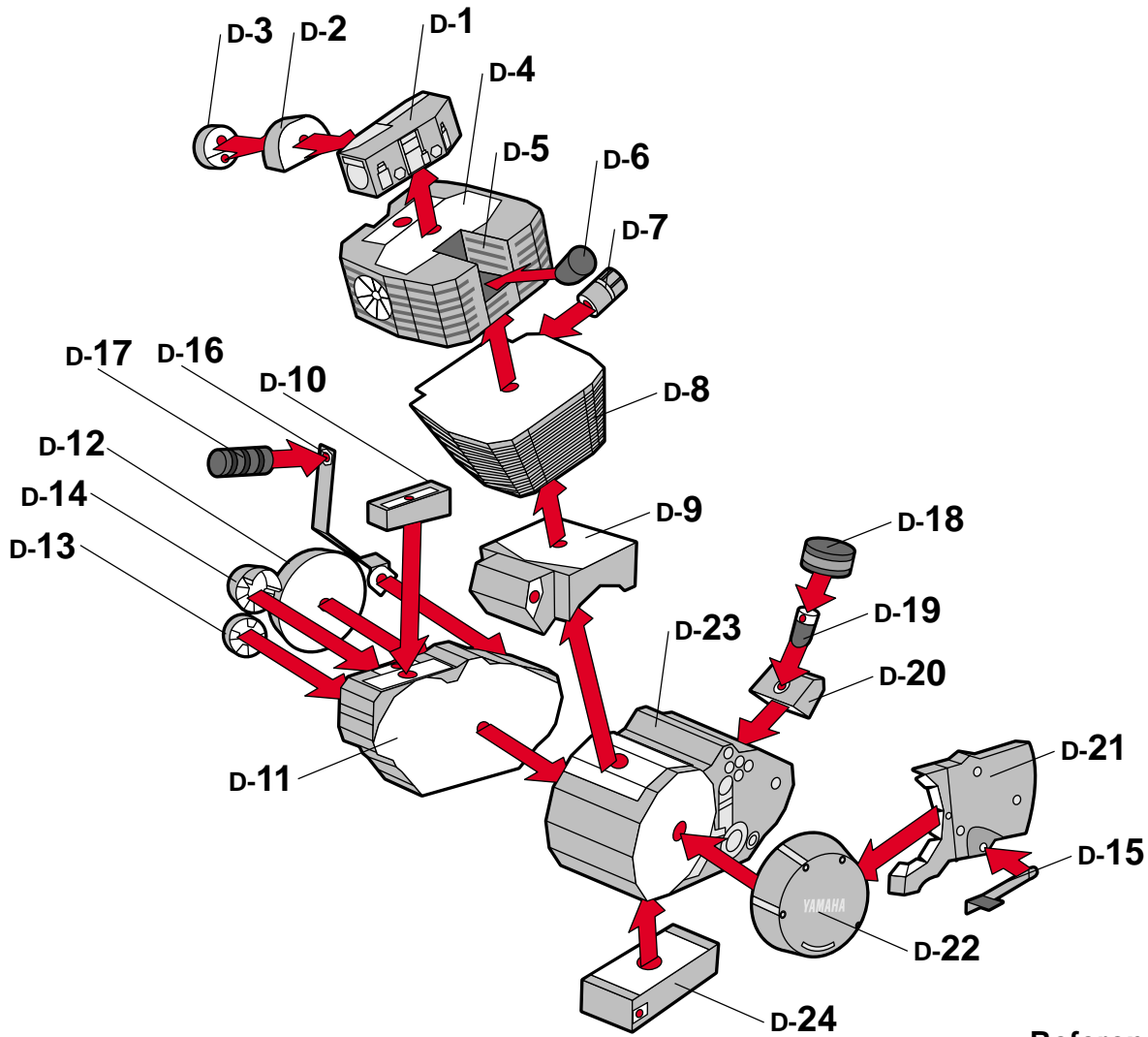

Reference photo

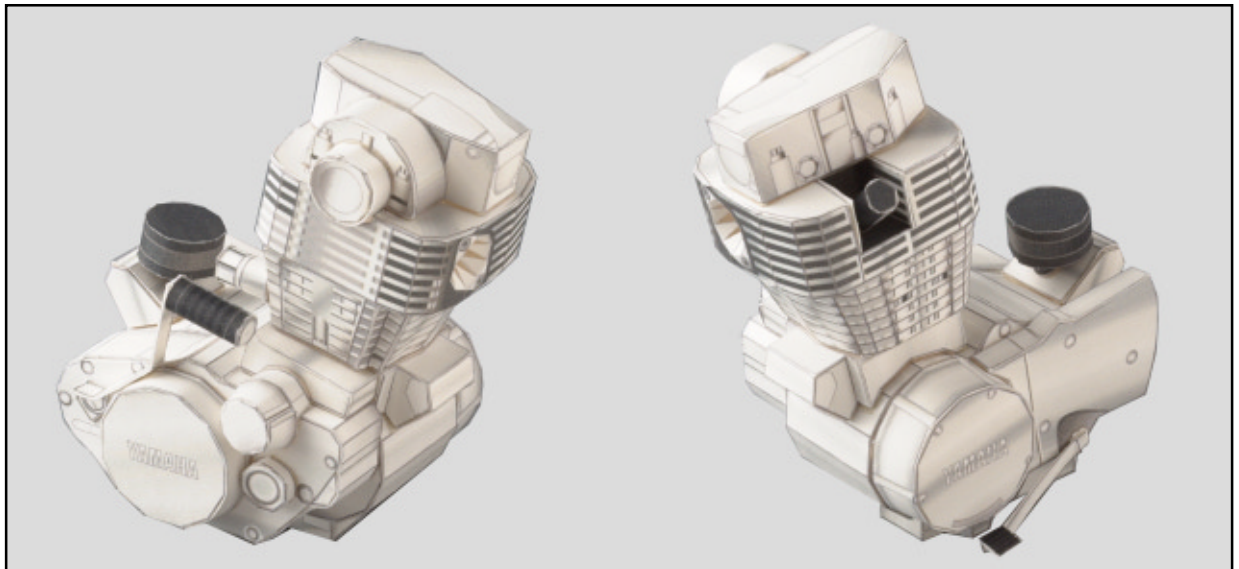

5 Assembling the Exhaust Pipes & Rear Fender

First, assemble each component by following the working method and markings. Then, refer to the illustration and photos below to glue the parts together.

Indication of Working Methods

 Fold or Curve  Glue

Exhaust Pipes

Sheet E, 9 parts in total

Fold each relevant part according to the assembly symbols.

Please use the ● dots on each component as reference when gluing surfaces.

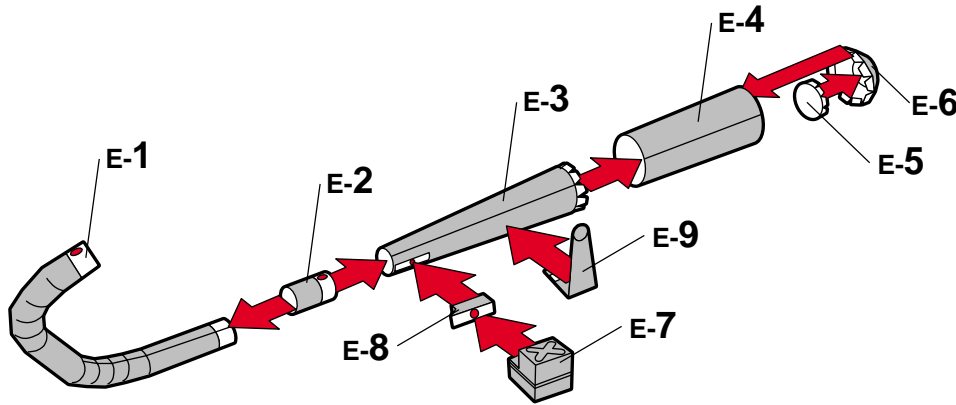

Reference photo

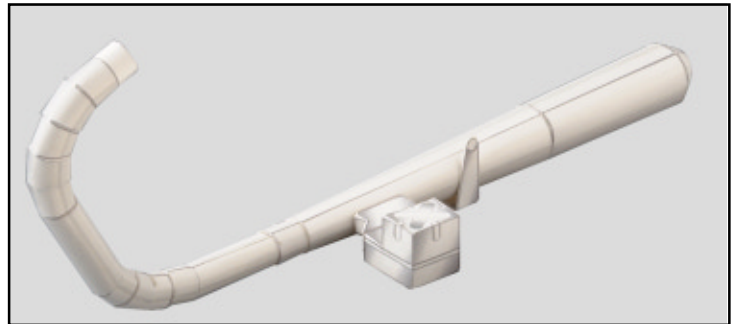

Rear Fender

Sheet F, 4 parts in total

Fold each relevant part according to the assembly symbols.

Please use the ● dots on each component as reference when gluing surfaces.

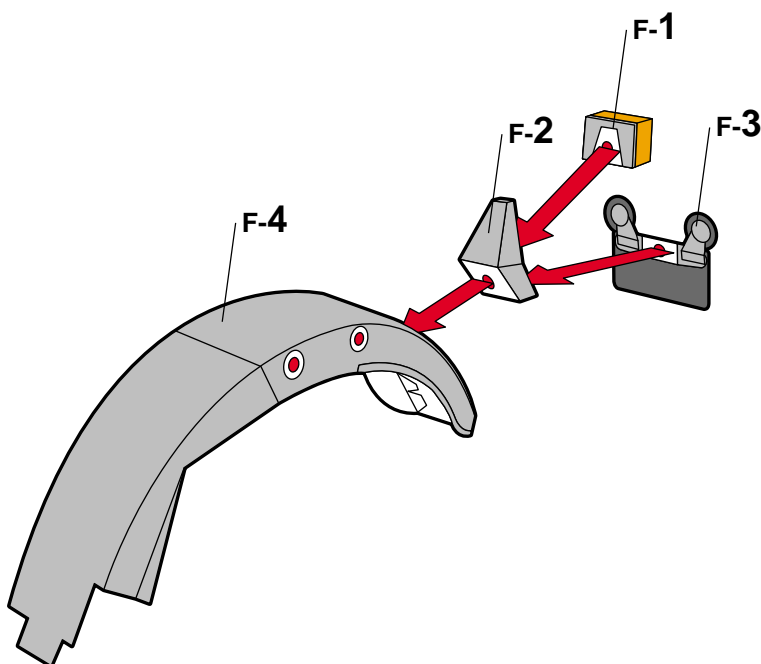

Reference photo



6 Assembling the Rear Arm

First, assemble each component by following the working method and markings. Then, refer to the illustration and photos below to glue the parts together.

Indication of Working Methods

 Fold or Curve
  Glue

Rear Arm

Sheet G, 25 parts in total

Fold each relevant part according to the assembly symbols.

Please use the ● dots on each component as reference when gluing surfaces.

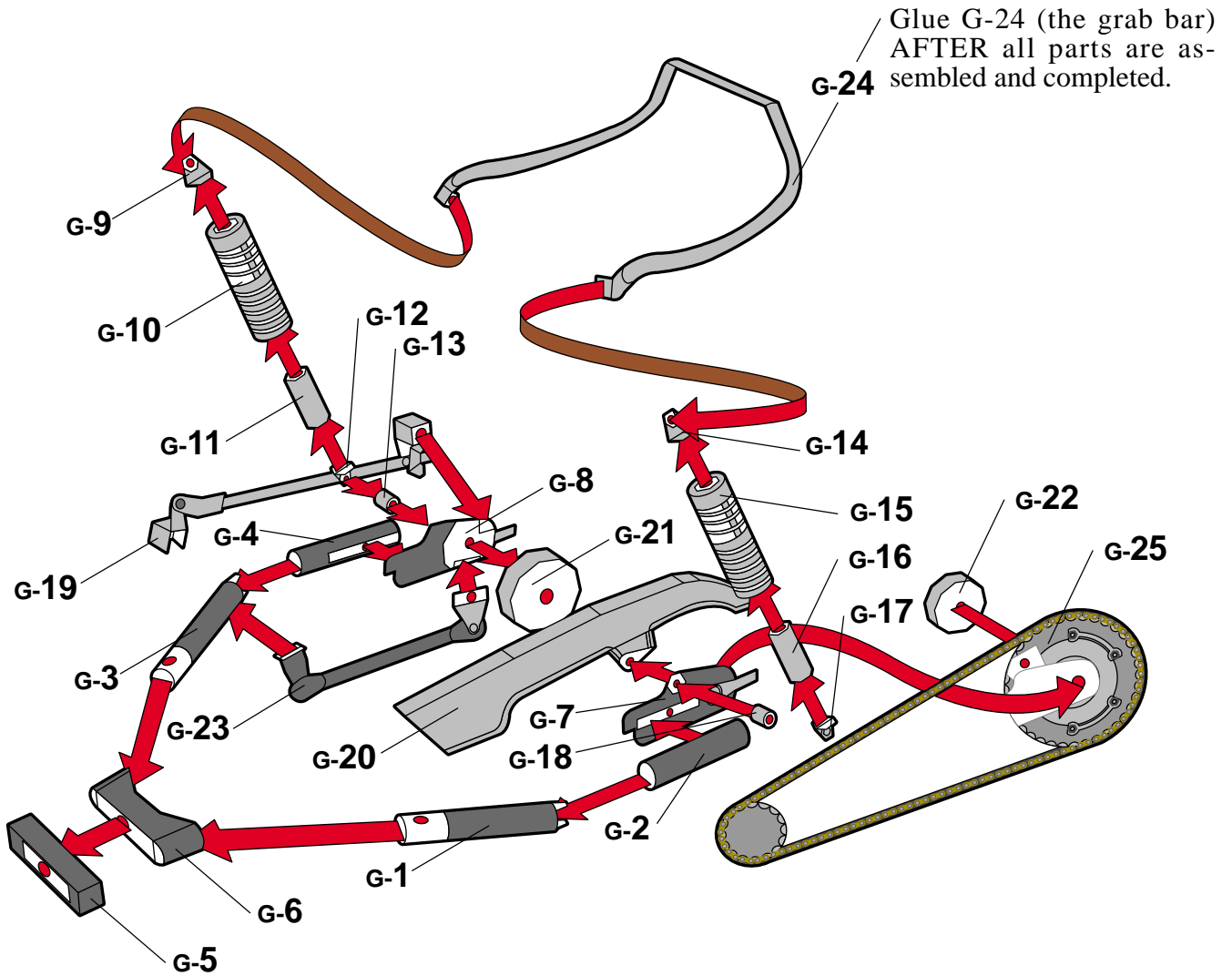

Reference photo



7 Assembling the Side Covers & Intake

First, assemble each component by following the working method and markings. Then, refer to the illustration and photos below to glue the parts together.

Indication of Working Methods

 Fold or Curve  Glue

Side Covers

Sheet H, 2 parts in total

Fold each relevant part according to the assembly symbols.

Please use the ● dots on each component as reference when gluing surfaces.

Assemble both side covers. The diagram shows how the right side cover looks. The numbers within the parentheses indicate the parts for the left side cover.

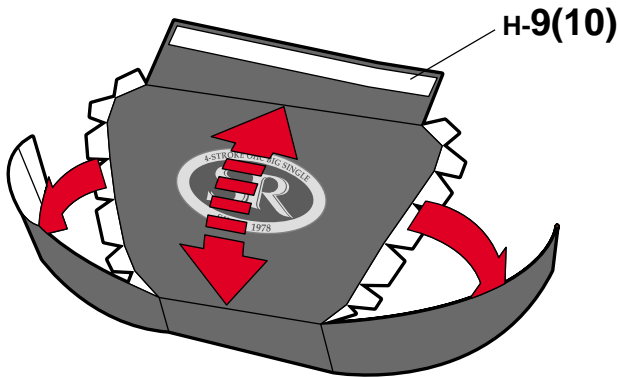

Reference photo



Intake

Sheet H, 8 parts in total

Fold each relevant part according to the assembly symbols.

Please use the ● dots on each component as reference when gluing surfaces.

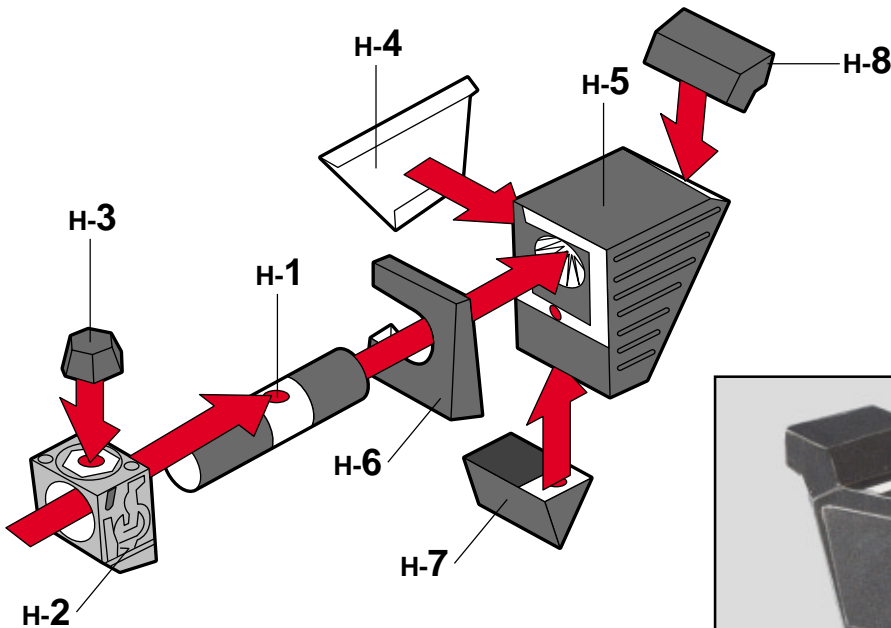

Reference photo



8 Assembling the Front Tire

First, assemble each component by following the working method and markings. Then, refer to the illustration and photos below to glue the parts together.

Indication of Working Methods

 Fold or Curve  Glue

Front Tire

Sheet I, 15 parts in total

Fold each relevant part according to the assembly symbols.

Please use the ● dots on each component as reference when gluing surfaces.

*Glue the completed front wheel to the assembled front tire.

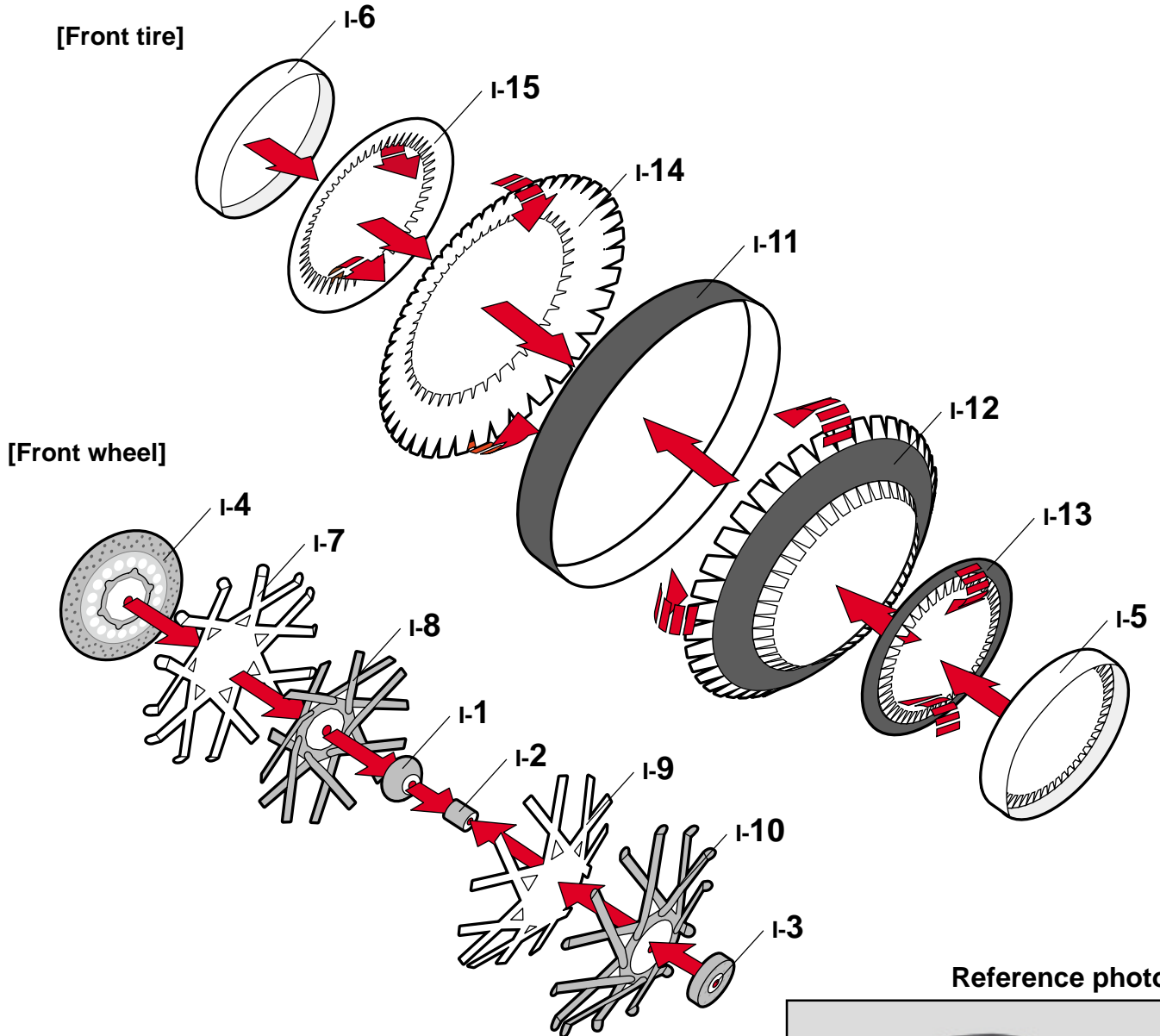

9 Assembling the Rear Tire

First, assemble each component by following the working method and markings. Then, refer to the illustration and photos below to glue the parts together.

Indication of Working Methods

 Fold or Curve  Glue

Rear Tire

Sheet J, 14 parts in total

Fold each relevant part according to the assembly symbols.

Please use the ● dots on each component as reference when gluing surfaces.

*Glue the completed rear wheel to the assembled rear tire.

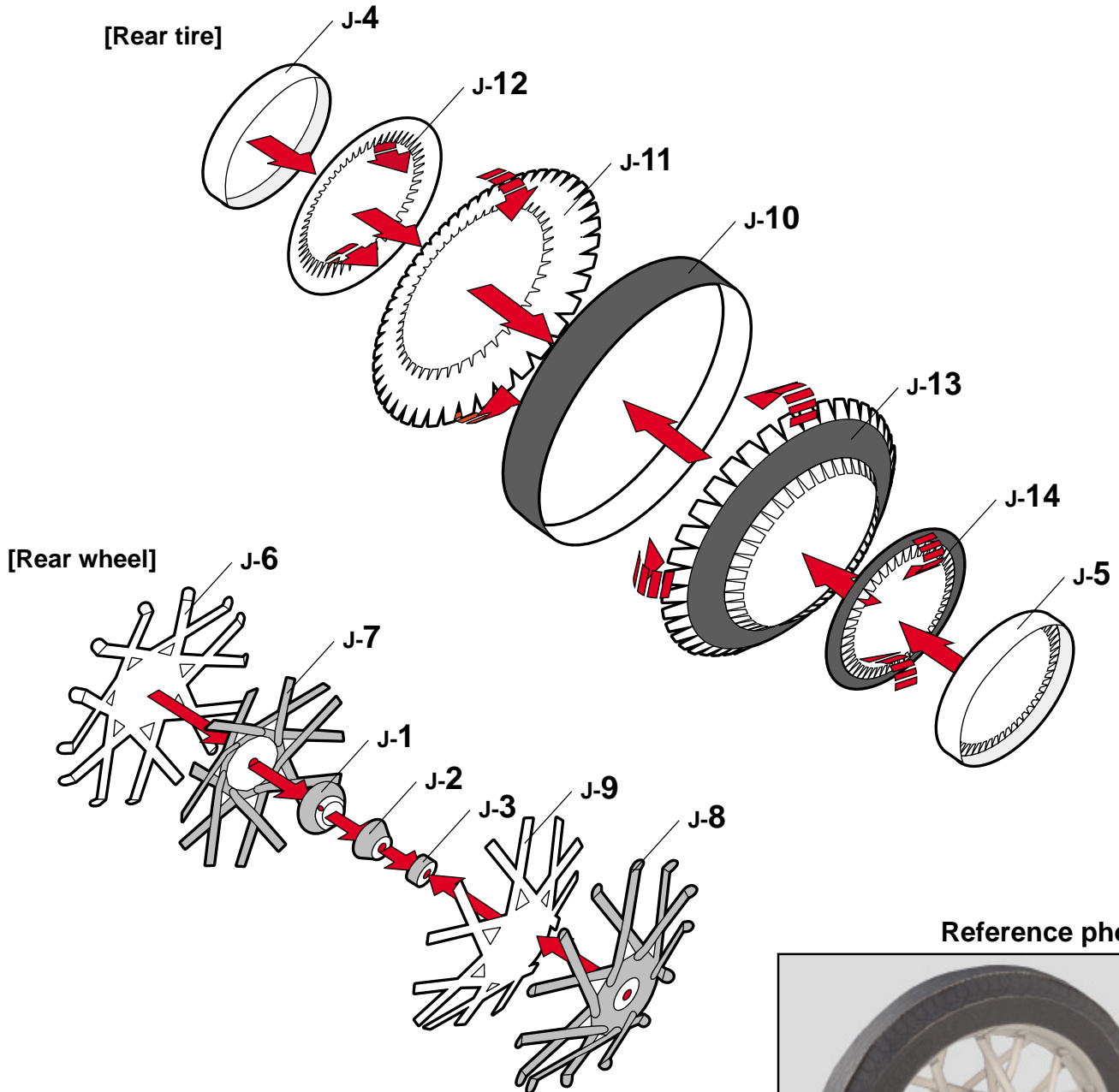

Reference photo



10 Finish

Please use the ● dots on each component as reference when gluing surfaces.

Assembly Instructions

glue the assembled parts in numerical order ❶ through ❾ .

- ❶ Glue the engine to the frame.
- ❷ Glue the rear arm to the engine and the frame.
- ❸ Glue the air filter to the engine and the frame.
- ❹ Glue the rear tire to the rear arm.
- ❺ Glue the rear fender to the frame.
- ❻ Glue the exhaust to the engine and the frame.
- ❼ Insert the upper steering column in the frame and then glue this part to the lower steering column.
- ❽ Glue the front tire to the lower steering column.
- ❾ Glue the right and left side covers.
- ❿ Glue the fuel tank/seat to the frame.
- ⓫ Glue the grab bar to the rear arm.

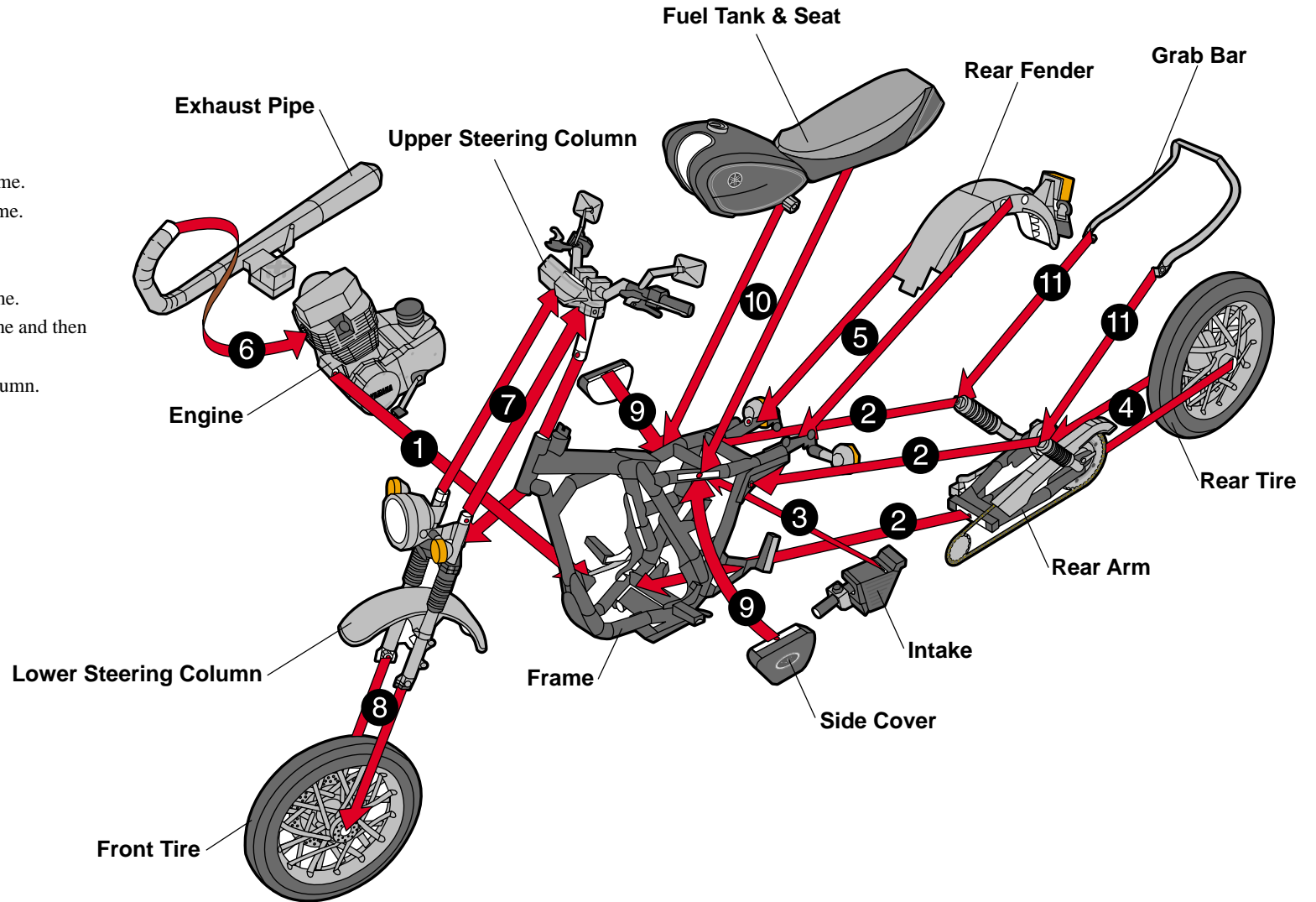

11 Assembled Model and the List of Parts

Please refer to the photo below when attaching each component.

RIGHT

Intake

- H-1 H-7
- H-2 H-8
- H-3
- H-4
- H-5
- H-6

Side Cover

- H-9
- H-10

Fuel Tank & Seat

- A-1
- A-2
- A-3
- A-4
- A-5

Rear Tire

- J-1 J-7 J-13
- J-2 J-8 J-14
- J-3 J-9
- J-4 J-10
- J-5 J-11
- J-6 J-12

Exhaust Pipe

- E-1 E-7
- E-2 E-8
- E-3 E-9
- E-4
- E-5
- E-6

Engine

- D-1 D-7 D-13 D-19
- D-2 D-8 D-14 D-20
- D-3 D-9 D-15 D-21
- D-4 D-10 D-16 D-22
- D-5 D-11 D-17 D-23
- D-6 D-12 D-18 D-24

Front Tire

- I-1 I-7 I-13
- I-2 I-8 I-14
- I-3 I-9 I-15
- I-4 I-10
- I-5 I-11
- I-6 I-12

FRONT

Steering

- B-1 B-7 B-13 B-19 B-25 B-31 B-37
- B-2 B-8 B-14 B-20 B-26 B-32 B-38
- B-3 B-9 B-15 B-21 B-27 B-33 B-39
- B-4 B-10 B-16 B-22 B-28 B-34
- B-5 B-11 B-17 B-23 B-29 B-35
- B-6 B-12 B-18 B-24 B-30 B-36

12 Assembled Model and the List of Parts

Please refer to the photo below when attaching each component.

LEFT

REAR

Rear Arm

- G-1 G-6 G-11 G-16 G-21
- G-2 G-7 G-12 G-17 G-22
- G-3 G-8 G-13 G-18 G-23
- G-4 G-9 G-14 G-19 G-24
- G-5 G-10 G-15 G-20 G-25



Frame

- C-1 C-7 C-13 C-19 C-25 C-31 C-37 C-43 C-49 C-55 C-61 C-67 C-73
- C-2 C-8 C-14 C-20 C-26 C-32 C-38 C-44 C-50 C-56 C-62 C-68 C-74
- C-3 C-9 C-15 C-21 C-27 C-33 C-39 C-45 C-51 C-57 C-63 C-69 C-75
- C-4 C-10 C-16 C-22 C-28 C-34 C-40 C-46 C-52 C-58 C-64 C-70 C-76
- C-5 C-11 C-17 C-23 C-29 C-35 C-41 C-47 C-53 C-59 C-65 C-71 C-77
- C-6 C-12 C-18 C-24 C-30 C-36 C-42 C-48 C-54 C-60 C-66 C-72 C-78



Rear Fender

- F-1
- F-2
- F-3
- F-4