

F

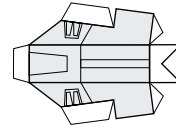

I

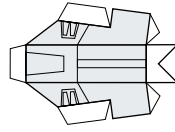
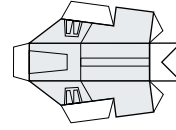
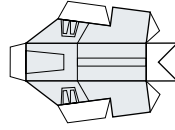

J

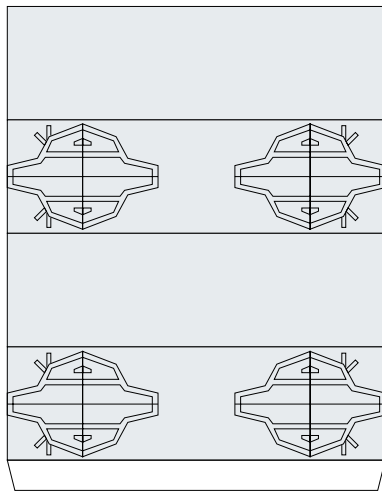
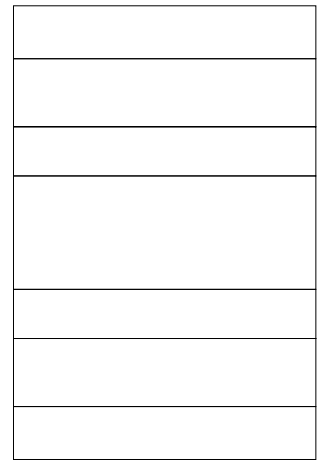

G



H

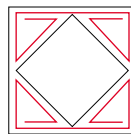

G、H断面図

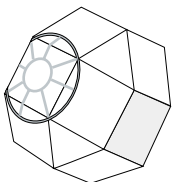

Fを組む

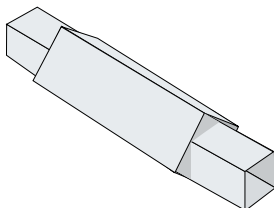

GにHを通す。

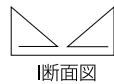

I断面図

Iを上図の用に組みGの固定用にする。

